

316364600001 / 316365600001 / 316366600001

ATTENTION : (pour connaître les caractéristiques d'utilisation consulter la carte grise).

Installé suivant nos recommandations, cet attelage vous donnera entière satisfaction. Nous dégageons toute responsabilité en cas de transformation ou d'utilisation illicite de celui-ci

FR

ACHTUNG: (Nutzungsmerkmale : siehe Fahrzeugschein)

Diese Anhängervorrichtung wird Sie voll zufrieden stellen, wenn Sie unsere Montageanleitung befolgen.
Im Falle der unerlaubten Veränderung oder des unerlaubten Gebrauchs lehnen wir jede Haftung ab.

DE

PLEASE NOTE : (to familiarise yourself with the operating characteristics refer to the log).

If this tow bar is fitted in accordance with our recommendations it will give a completely satisfaction.
We cannot accept any responsibility in the event of changes to or improper use of this item.

EN

BEMÆRK : (for yderligere oplysninger om anvendelsesforhold henvises der til registreringsattesten)

Hvis dette anhængertræk monteres i henhold til vores anvisninger, vil det være til din fulde tilfredshed.
Vi fralægger os ethvert ansvar ved ulovlig ændring eller brug af anhængertrækket.

DA

ΠΡΟΣΟΧΗ : (για να πληροφορηθείτε τα χαρακτηριστικά χρήσης συμβουλευτείτε την γκριζα κάρτα)

Εγκατεστημένο σύμφωνα με τις συστάσεις μας, αυτό το σύστημα ρυμούλκησης θα σας ικανοποιήσει πλήρως. Απεκδυόμεθα πάσης ευθύνης σε περίπτωση μετατροπής ή παράνομης χρήσης αυτού.

EL

ATENCIÓN: (para conocer las características de utilización, consultar el permiso de circulación)

Instalado siguiendo nuestras recomendaciones, este enganche le dará total satisfacción. No asumiremos ninguna responsabilidad en caso de que haya sido transformado o utilizado ilícitamente.

ES

UWAGA (charakterystyki użytkowania należy sprawdzić w dowodzie rejestracyjnym)

Dyszel holowniczy będzie funkcjonował we właściwy sposób po zainstalowaniu go zgodnie z zaleceniami. Nie ponosimy żadnej odpowiedzialności w przypadku wprowadzenia zmian lub niedozwolonego użycia

PL

HUOMIO: (käyttöominaisuuksiin tutustumiseksi on katsottava rekisteriotetta)

Suosituksen mukaan asennettuna tämä vetokoukku täyttää odotuksesi.
Emme ota vastuuta, jos laitetta muutetaan tai käytetään ohjeiden vastaisesti.

FI

ATTENZIONE : (per conoscere le caratteristiche d'uso consultare il libretto di circolazione)

Installato seguendo le nostre raccomandazioni, questo gancio da traino vi lascerà completamente soddisfatti.
Respingiamo ogni responsabilità in caso di trasformazione o utilizzo illecito dello stesso.

IT

LET OP : (voor gebruikskennmerken het kentekenbewijs raadplegen)

Indien u de koppeling volgens onze aanbevelingen heeft geïnstalleerd, zal het u tot volle tevredenheid stemmen. Wij stellen ons niet aansprakelijk in geval van wijziging of onrechtmatig gebruik.

NL

ADVARSEL: (for kunnskap om bruksegenskapene, se vognkortet)

Ved å installere innretningen i samsvar med våre anbefalinger vil du få maksimalt utbytte av dette tilhengerfestet. Vi fraskriver oss alt ansvar hvis tilhengerfestet endres eller brukes på ulovlig måte.

NO

POZOR: (užívateľské charakteristiky naleznete v technickém průkazu)

Tažné zařízení instalované dle našich doporučení vás plně uspokojí. V případě přestavby nebo neoprávněného užívání se zbavujeme veškeré odpovědnosti

CZ

VARNING: (Läs igenom registreringsbeviset för att ta reda på rådande användningsvillkor)

Om du monterar produkten enligt våra anvisningar kommer du uppnå bästa möjliga resultat. Vi avsäger oss allt ansvar i de fall kunden inte följt våra anvisningar fullt ut.

SV

FIGYELEM : (a használati jellegzetességeket a forgalmi engedélyből ismerheti meg)

A vonóhorog előírásainknak megfelelő felszerelés esetén a terméket teljes elégedettséggel használhatja. A termék átalakítása vagy tiltott használata esetén semmilyen felelősséget nem vállalunk.

HU

ВНИМАНИЕ : (чтобы ознакомиться с рабочими характеристиками, изучите технический паспорт автомашины)

Установленное при соблюдении рекомендаций, данное тягово-сцепное устройство в полной мере удовлетворит ваши потребности. Производитель не несет никакой ответственности в случае деформации или

RU



siarr
WESTFALIA AUTOMOTIVE



westfalia
AUTOMOTIVE

316 364 600 001 (SI 216)

316 365 600 001 (SI 216)

316 366 600 001 (SI 215)

D U S T E R

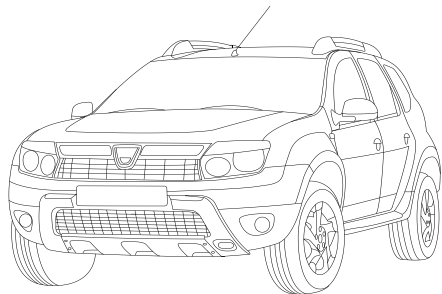

D U S T E R

10/2017 →

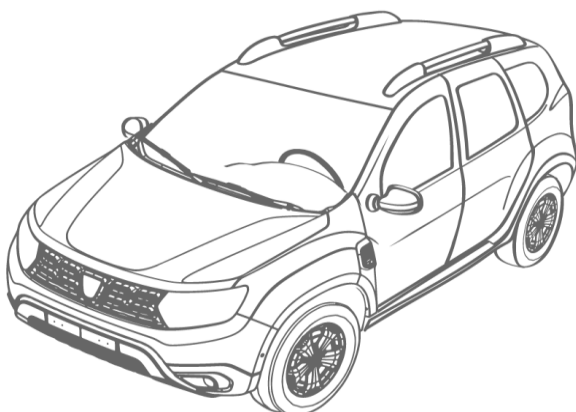

1600 kg



1950 kg



75 kg



8,62 kN

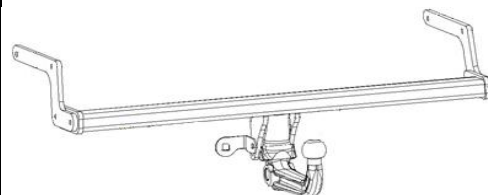

316364 : 18 kg

316365 : 16,5 kg

316366 : 18,5 kg



e24*55R*01*0346 - 316364

e24*55R*01*0346 - 316365

e24*55R*01*0345 - 316366

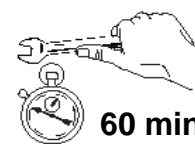
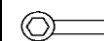
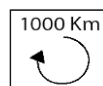
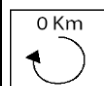

60 min

316364

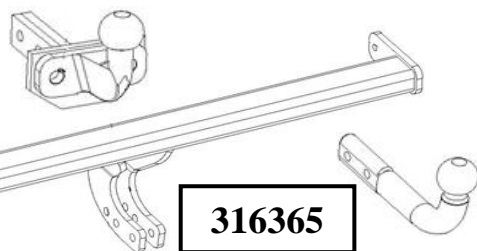

316365

316366

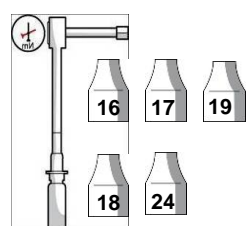
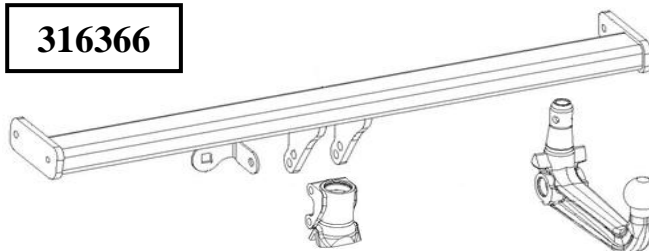

16

17

19

18

24

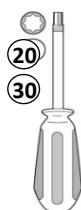

20

30



16

17

18





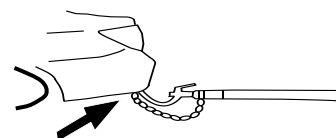
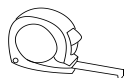
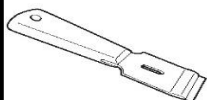



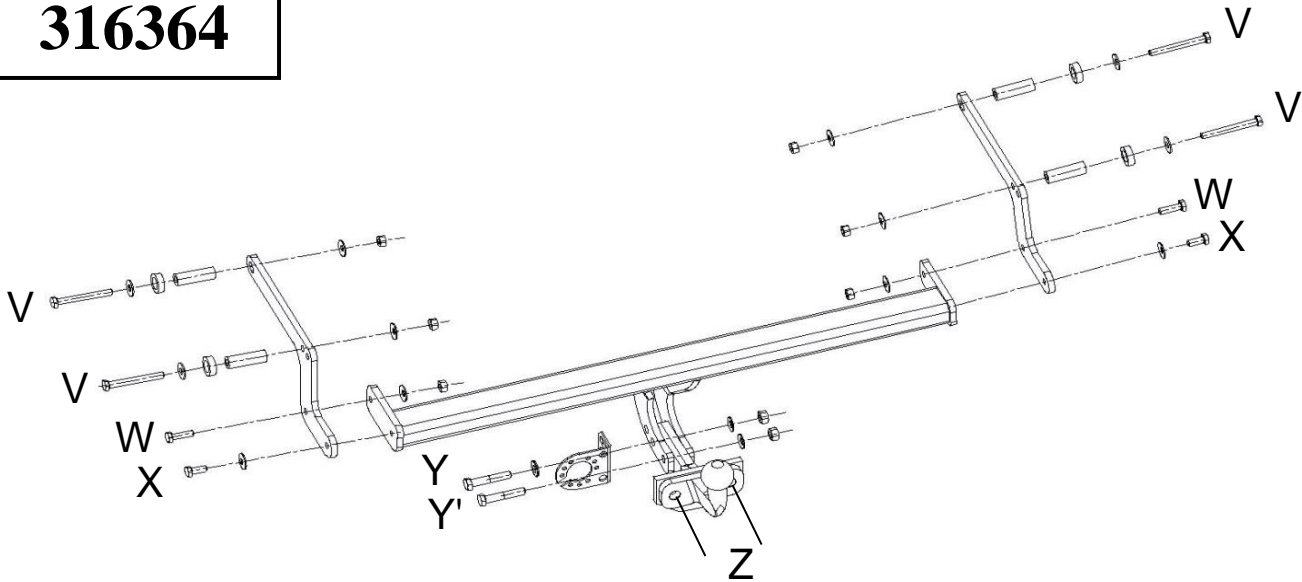











19

OK











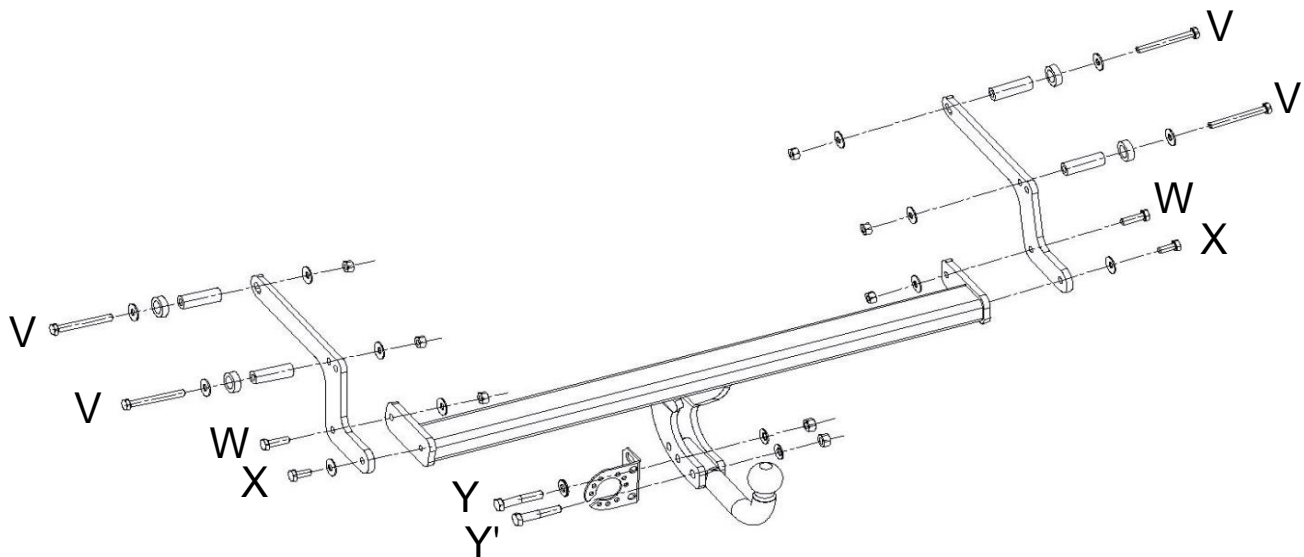









316364











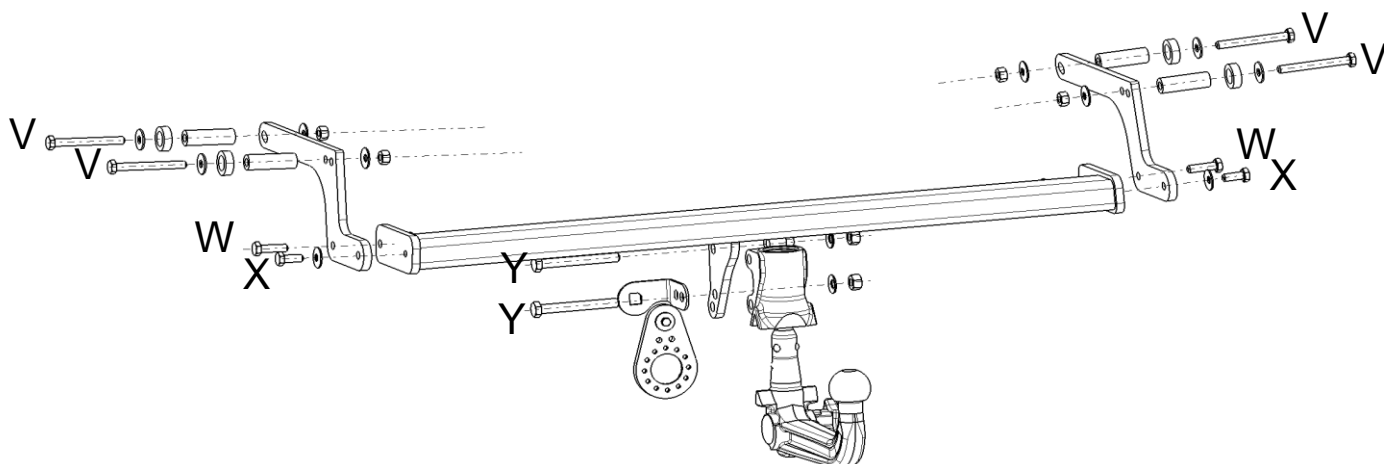





VISSERIE		QTE
V	 HM10x90 - 47Nm	x 4
	 CS 10/27	x 4
	 L10,5/27	x 4
	 20/32 - ep.10mm	x 4
	 M10	x 4
	 Ø10,5/20 - L. 60mm	x 4
W	 HM10x35 - 47Nm	x 2
	 CS 10/27	x 2
	 M10	x 2
X	 HM10x35 - 47Nm	x 2
	 CS 10/27	x 2
Y	 HM12x65 - 81Nm	x 1
	 CS12/24	x 1
	 M12	x 1
Y'	 HM12x65 - 81Nm	x 1
	 CS12/24	x 1
	 M12	x 1
	 D12	x 1
Z	 HM16x40 - 195Nm	x 2
	 M16	x 2
	 DEC16	x 2

316365



VISSERIE		QTE
V	 HM10x90 - 47Nm	x 4
	 CS 10/27	x 4
	 L10,5/27	x 4
	 20/32 - ep.10mm	x 4
	 M10	x 4
	 Ø10,5/20 - L. 60mm	x 4
W	 HM10x35 - 47Nm	x 2
	 CS10/27	x 2
	 M10	x 2
X	 HM10x35 - 47Nm	x 2
	 CS10/27	x 2
Y	 HM12x65 - 81Nm	x 1
	 CS12/24	x 1
	 M12	x 1
Y'	 HM12x65 - 81Nm	x 1
	 CS12/24	x 1
	 M12	x 1
	 L13/27	x 1

316366

VISSERIE		QTÉ
V	 HM10x90 - 47Nm	x 4
	 CS 10/27	x 4
	 L10,5/27	x 4
	 20/32 - ep.10mm	x 4
	 M10	x 4
	 Ø10,5/20 - L. 60mm	x 4
W	 HM10x35 - 47Nm	x 2
	 CS10/27	x 2
	 M10	x 2
X	 HM10x35 - 47Nm	x 2
	 CS10/27	x 2
Y	 HM12x100 - 114Nm	x 2
	 CS12/24	x 2
	 M12	x 2

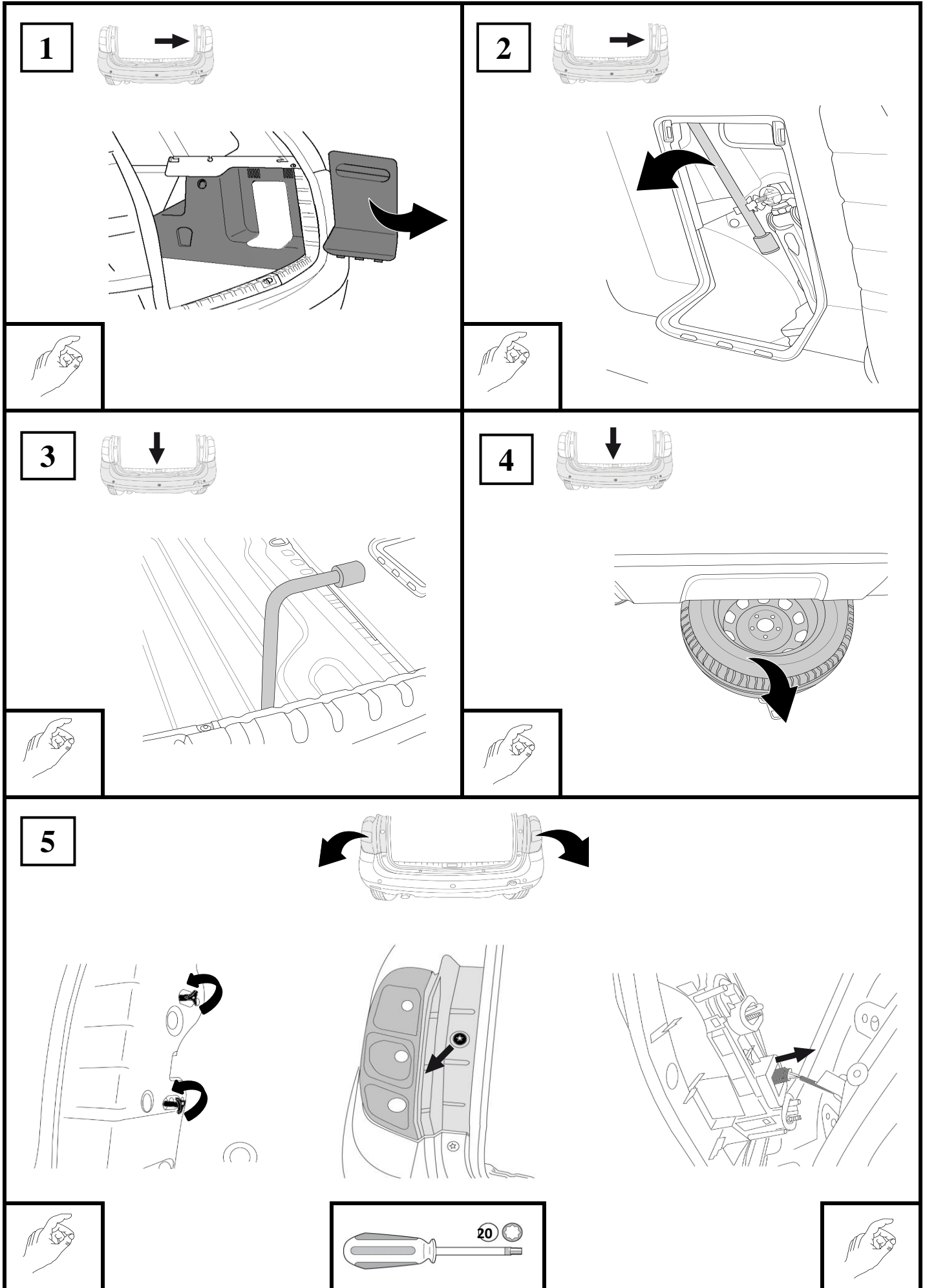

6

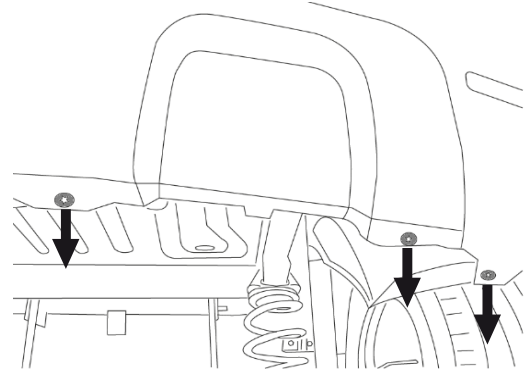
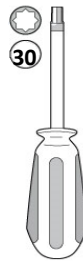
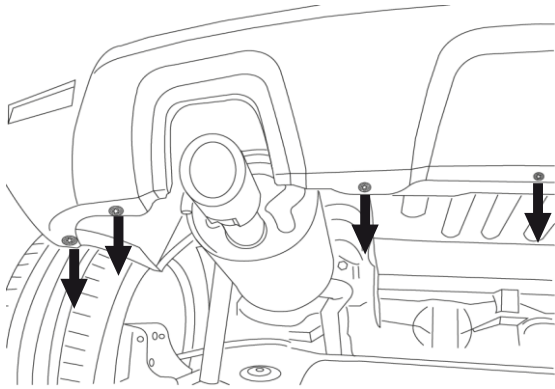
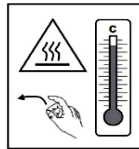
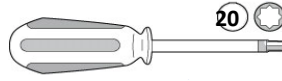
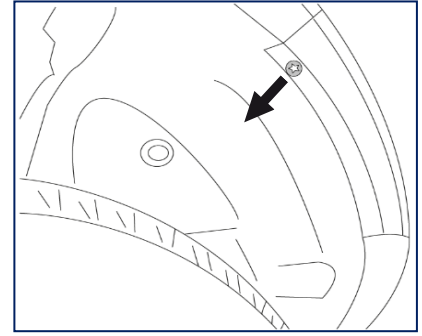
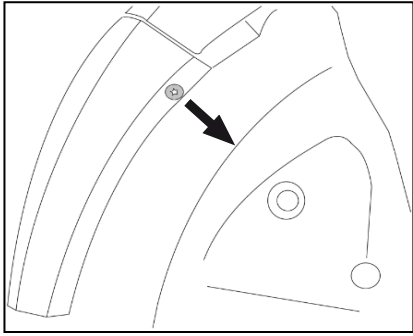
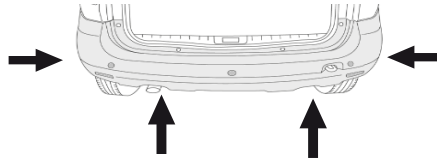

7

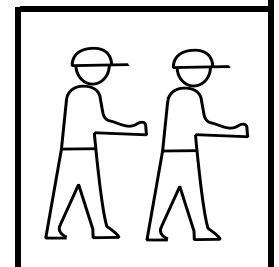
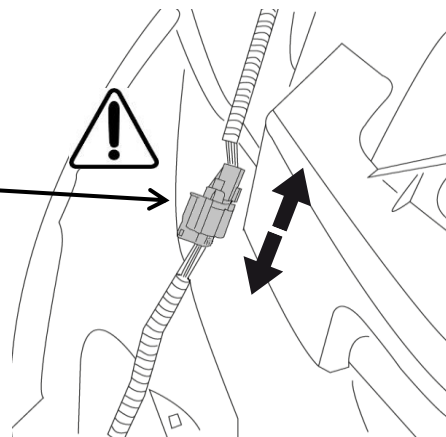
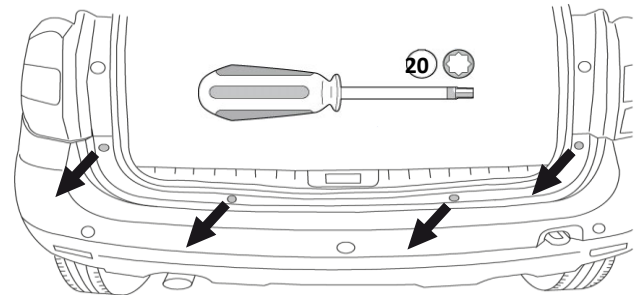
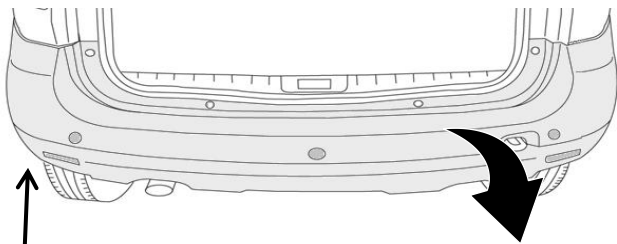
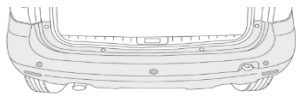

8

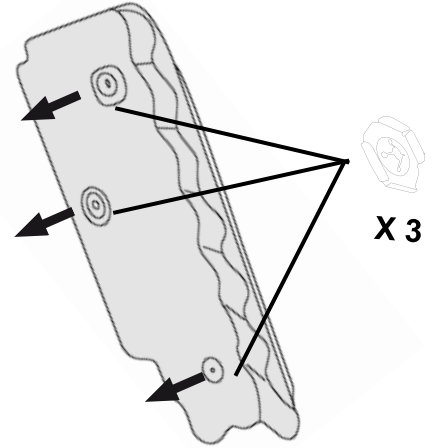
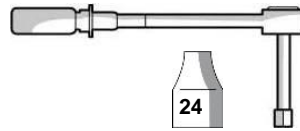
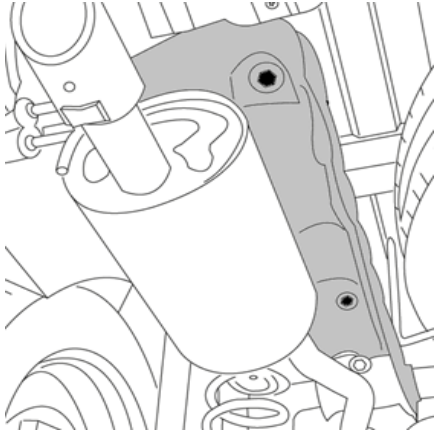
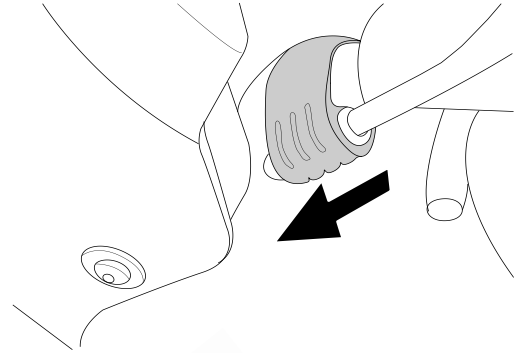
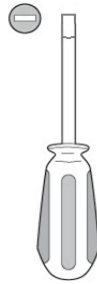
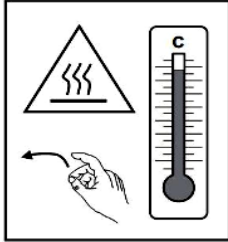

9

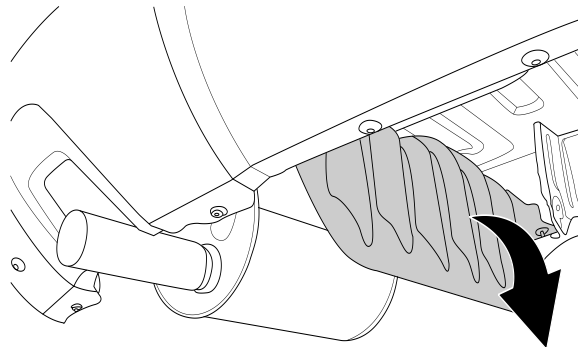

10

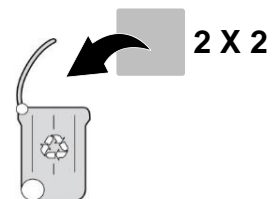
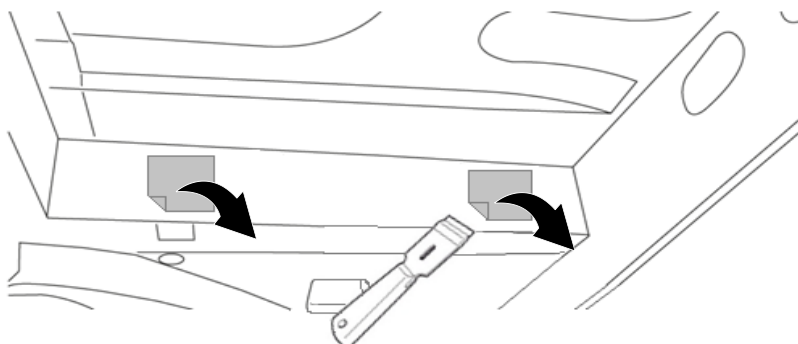
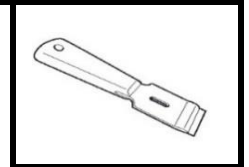
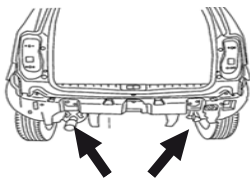

11

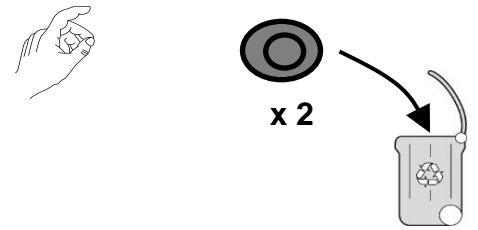
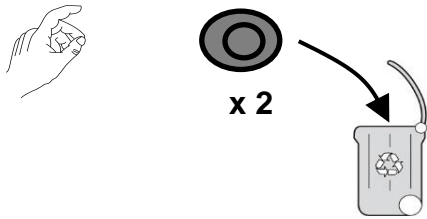
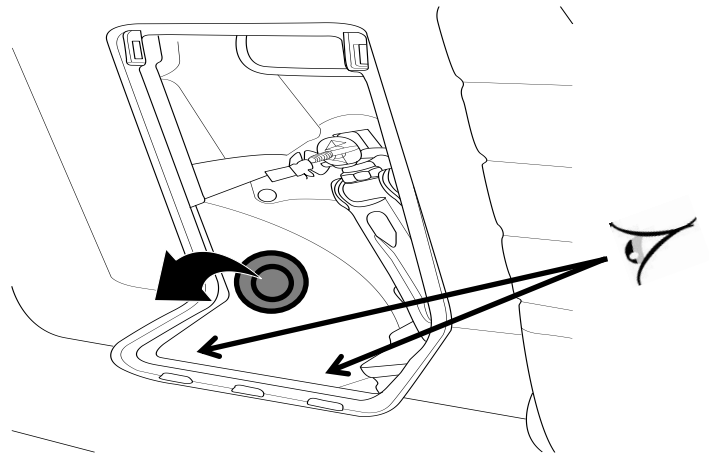
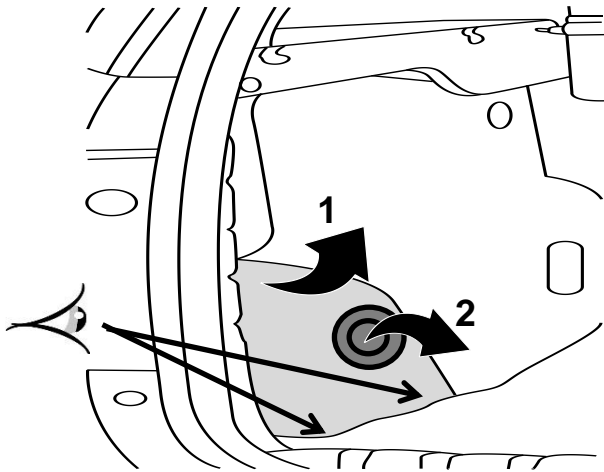
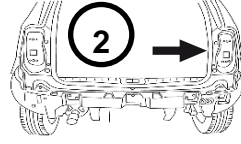
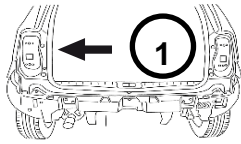

12

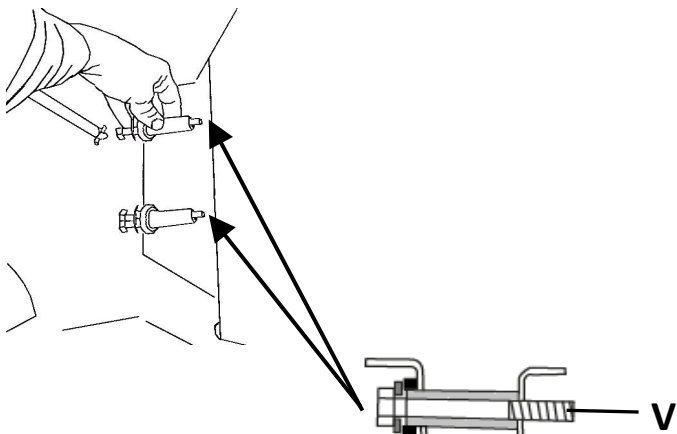
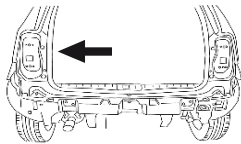

13

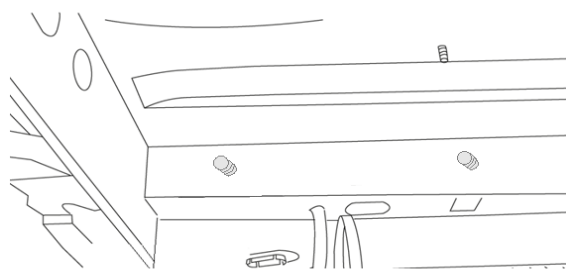
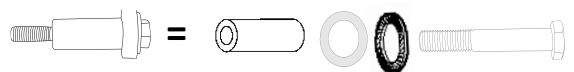
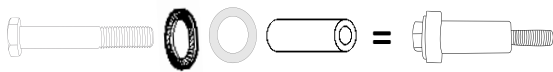
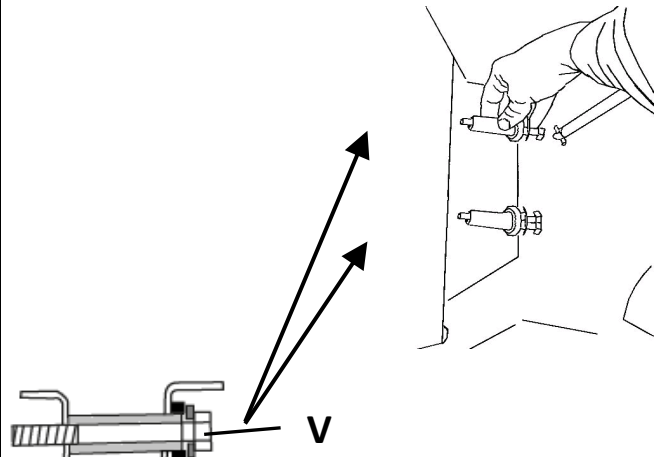
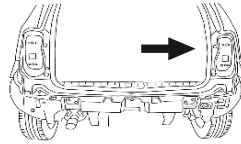

14

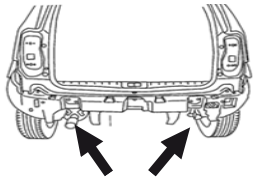

16 - 17

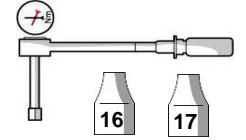

47 Nm

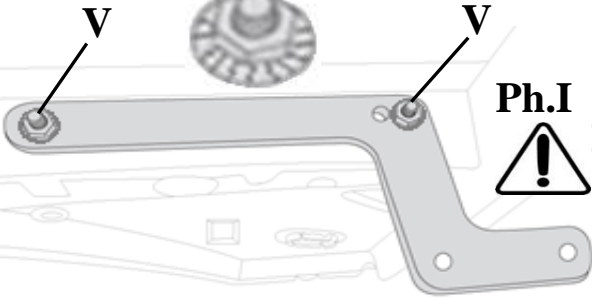

Ph.I

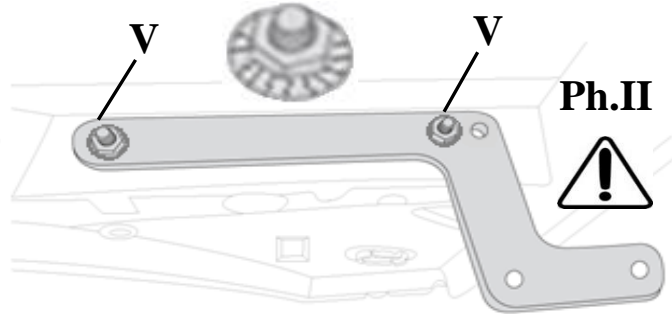

Ph.II



15

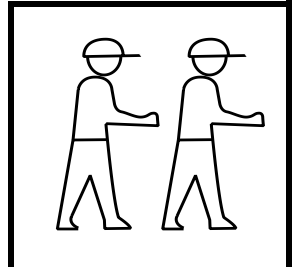
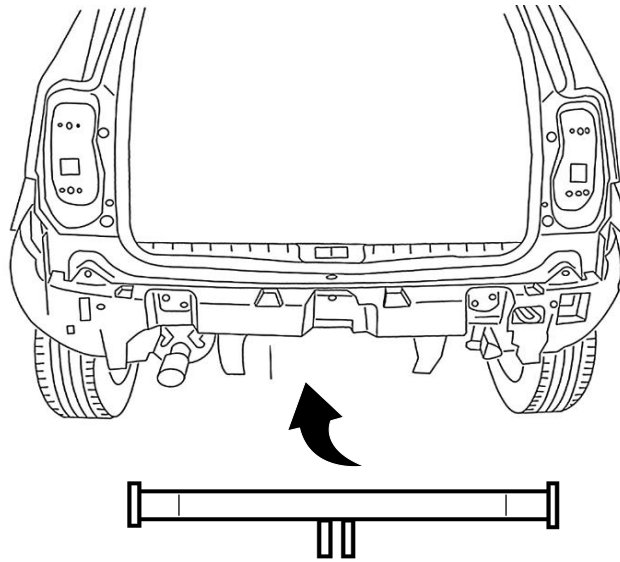

16

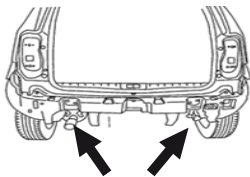

16 - 17

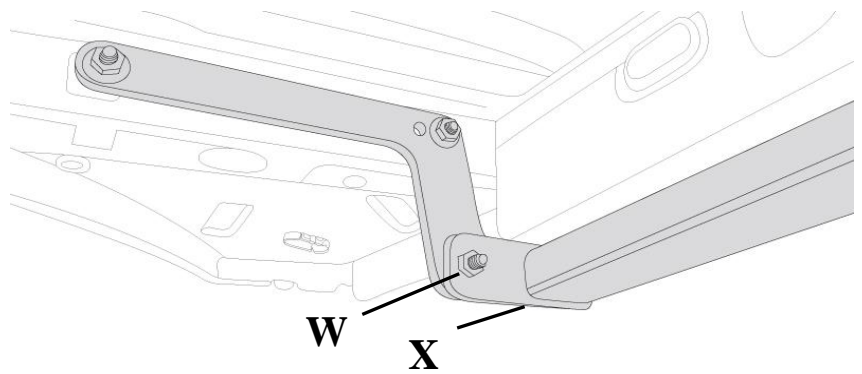

W

X



47 Nm

17

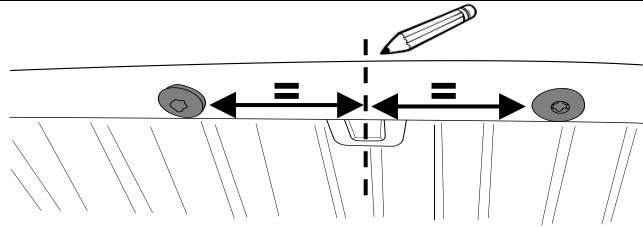
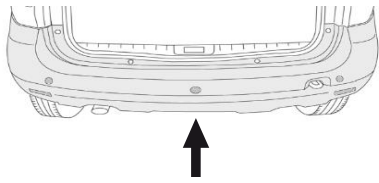

18

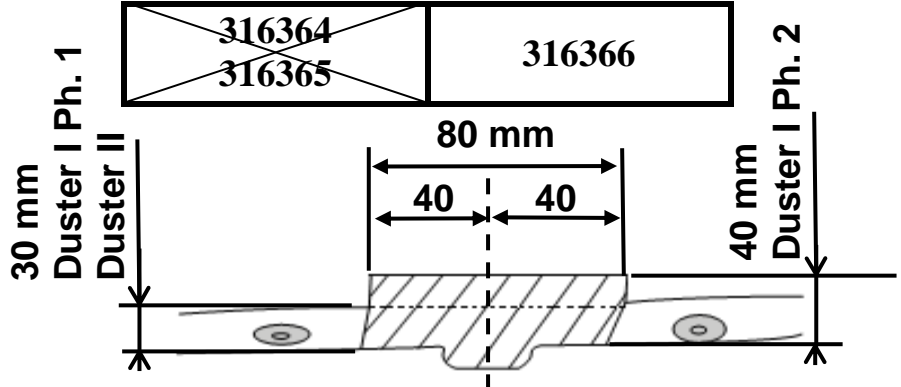
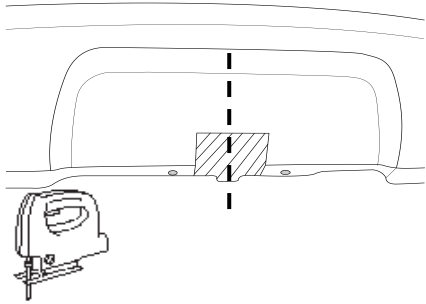

19



Y Y' = 81 Nm
Z = 195 Nm

316 364

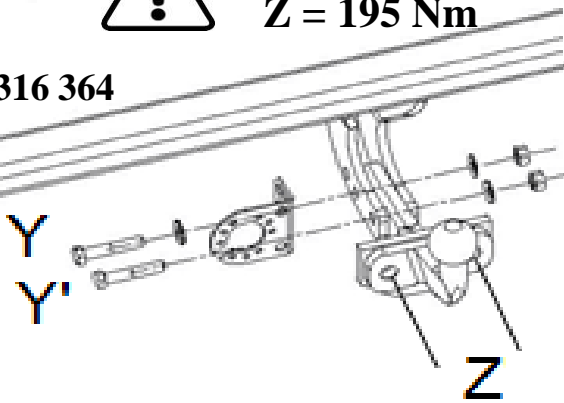

81 Nm

316 365

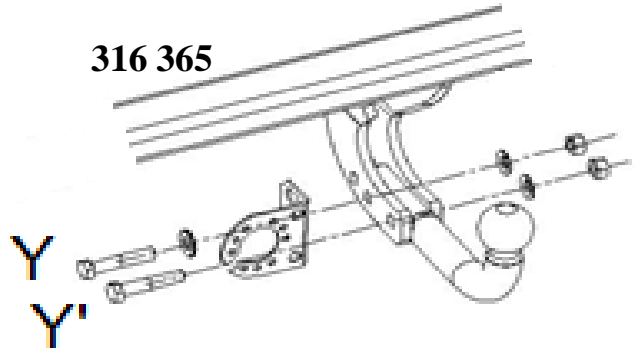

316 366

DUSTER

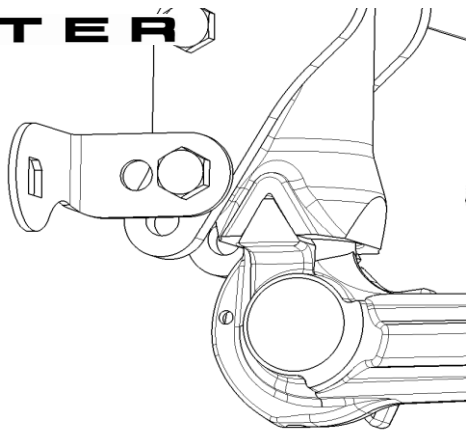

DUSTER

10/2017 →

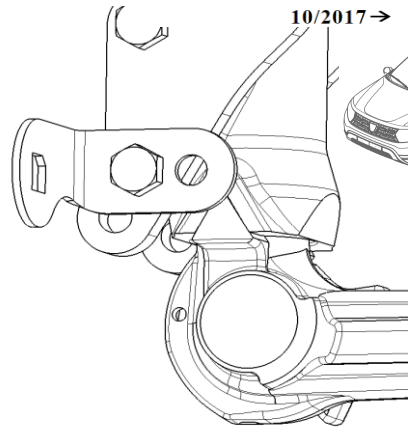

18 - 19 - 24

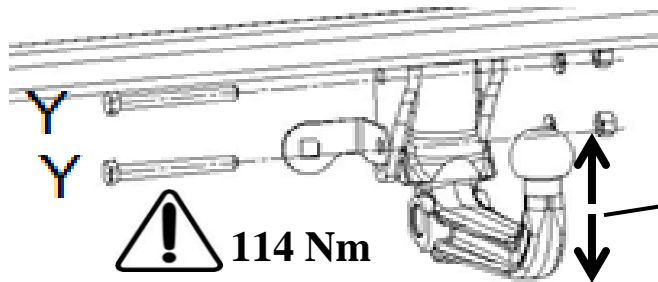
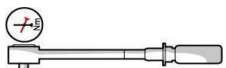

114 Nm

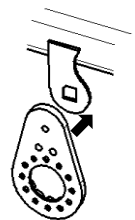

20

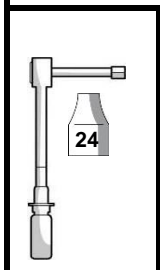
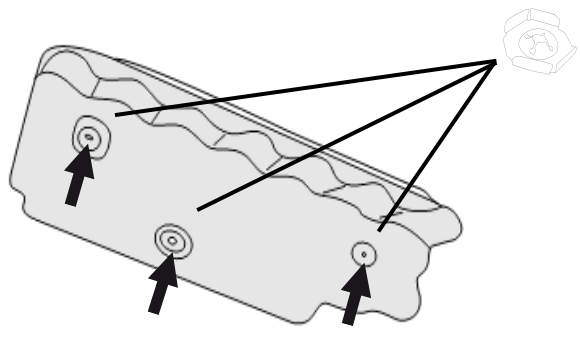
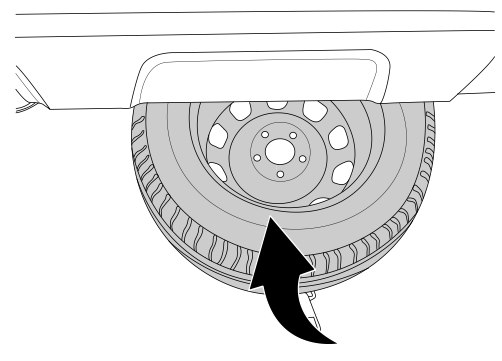
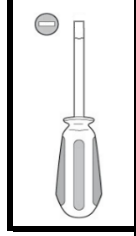
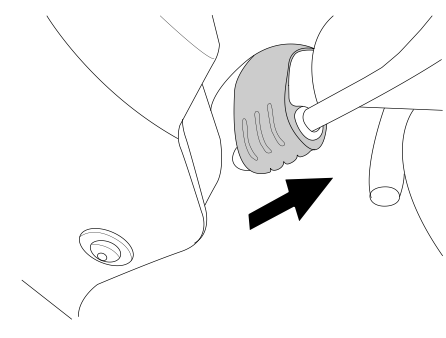
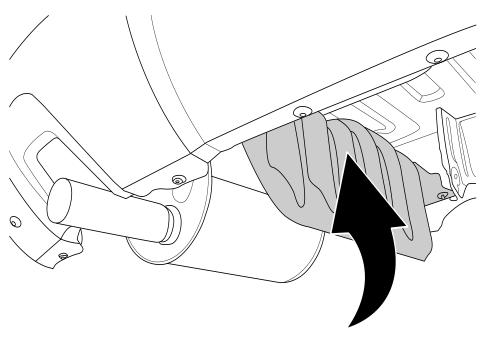

21

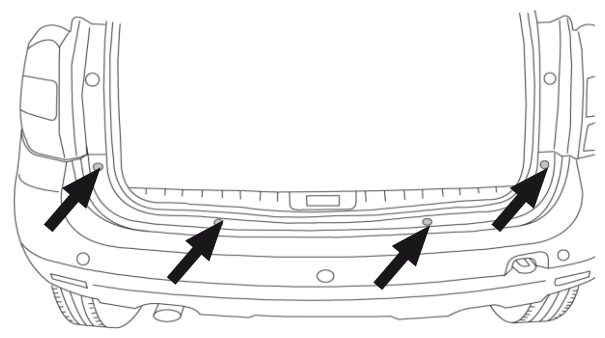
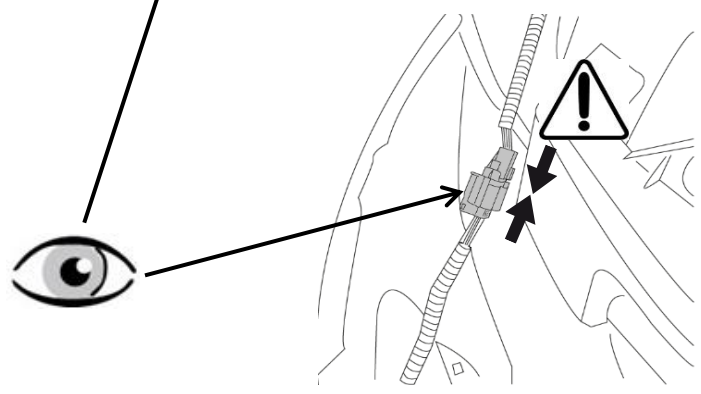
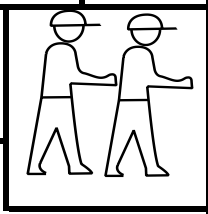
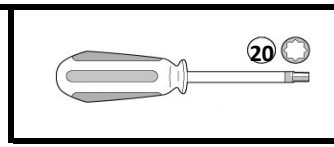
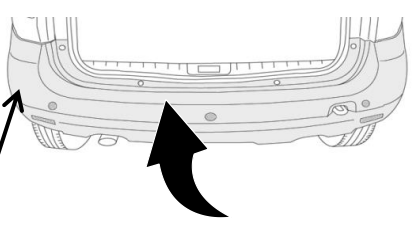

22

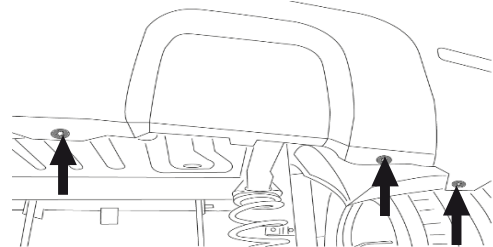
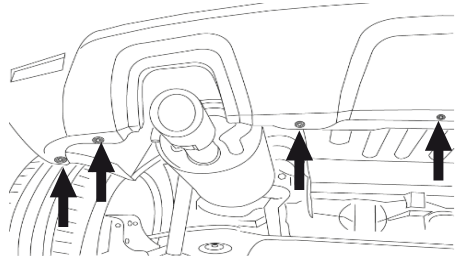
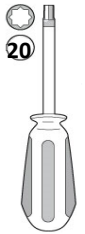
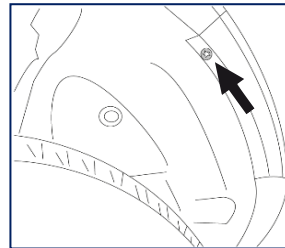
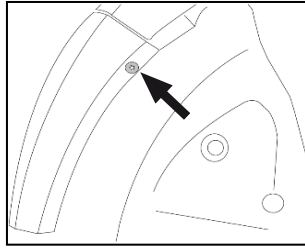
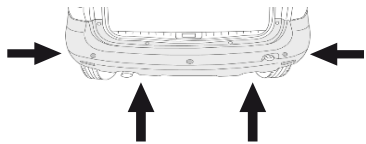

23

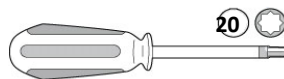
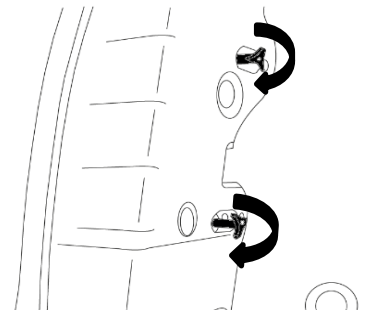
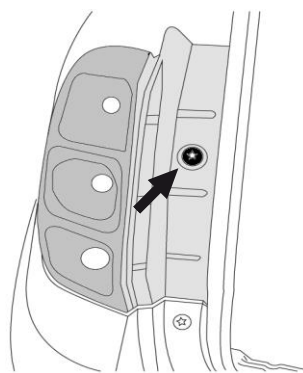
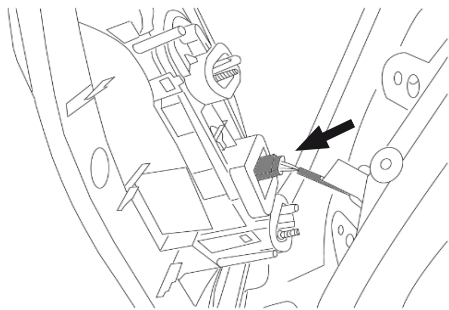
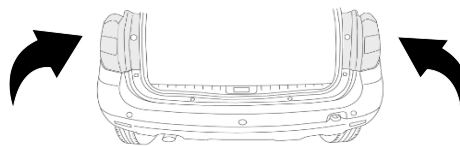

24

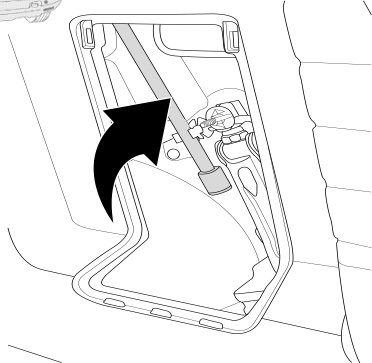
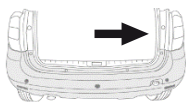

25

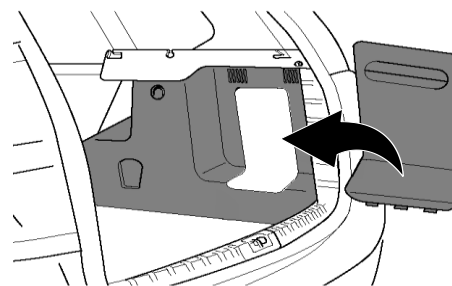
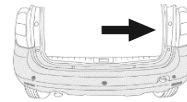

Dispositivo di traino tipo : **316364 / 316365 / 316366**

Per autoveicolo : **Dacia Duster**

Tipo funzionale : **SD**

Classe e tipo di attacco : **A50-X**

Omologazione : **e24*55R*01*0346 (316364 - 316365) - e24*55R*01*0345 (316366)**

Valore D : **8,62 kN**

Carico verticale max. S : **75 kg**

Massa rimorchiabile : vedi carta di circolazione dell'autoveicolo



In base alla Direttiva europea R55, la massa massima rimorchiabile del dispositivo di traino è determinata dal valore di prova "D" così definito :

$$D = (T \times C) / (T + C) \times 0,00981 = 8,62 \text{ kN}$$

dove : T = Massa complessiva max. della motrice (in kg) e C = Massa rimorchiabile max. della motrice (in kg)

DICHIARAZIONE DI CORRETTO MONTAGGIO :

la sottoscritta Ditta dichiara che il dispositivo di traino tipo _____ è stato installato a regola d'arte, nel rispetto dei punti d'attacco e delle prescrizioni fornite dalla Casa costruttrice

sul veicolo Dacia Duster

targato _____

li _____

Si dichiara inoltre di aver informato l'utente del veicolo sull'USO e MANUTENZIONE del dispositivo stesso.

timbro et firma





holownicze.pl