

# 316364600001 / 316365600001 / 316366600001

**ATTENTION : (pour connaître les caractéristiques d'utilisation consulter la carte grise).**

Installé suivant nos recommandations, cet attelage vous donnera entière satisfaction. Nous dégageons toute responsabilité en cas de transformation ou d'utilisation illicite de celui-ci

FR

**ACHTUNG: (Nutzungsmerkmale : siehe Fahrzeugschein)**

Diese Anhängervorrichtung wird Sie voll zufrieden stellen, wenn Sie unsere Montageanleitung befolgen.  
Im Falle der unerlaubten Veränderung oder des unerlaubten Gebrauchs lehnen wir jede Haftung ab.

DE

**PLEASE NOTE : (to familiarise yourself with the operating characteristics refer to the log).**

If this tow bar is fitted in accordance with our recommendations it will give a completely satisfaction.  
We cannot accept any responsibility in the event of changes to or improper use of this item.

EN

**BEMÆRK : (for yderligere oplysninger om anvendelsesforhold henvises der til registreringsattesten)**

Hvis dette anhængertræk monteres i henhold til vores anvisninger, vil det være til din fulde tilfredshed.  
Vi fralægger os ethvert ansvar ved ulovlig ændring eller brug af anhængertrækket.

DA

**ΠΡΟΣΟΧΗ : (για να πληροφορηθείτε τα χαρακτηριστικά χρήσης συμβουλευτείτε την γκριζα κάρτα)**

Εγκατεστημένο σύμφωνα με τις συστάσεις μας, αυτό το σύστημα ρυμούλκησης θα σας ικανοποιήσει πλήρως. Απεκδυόμεθα πάσης ευθύνης σε περίπτωση μετατροπής ή παράνομης χρήσης αυτού.

EL

**ATENCIÓN: (para conocer las características de utilización, consultar el permiso de circulación)**

Instalado siguiendo nuestras recomendaciones, este enganche le dará total satisfacción. No asumiremos ninguna responsabilidad en caso de que haya sido transformado o utilizado ilícitamente.

ES

**UWAGA (charakterystyki użytkowania należy sprawdzić w dowodzie rejestracyjnym)**

Dyszel holowniczy będzie funkcjonował we właściwy sposób po zainstalowaniu go zgodnie z zaleceniami. Nie ponosimy żadnej odpowiedzialności w przypadku wprowadzenia zmian lub niedozwolonego użycia

PL

**HUOMIO: (käyttöominaisuuksiin tutustumiseksi on katsottava rekisteriotetta)**

Suosituksen mukaan asennettuna tämä vetokoukku täyttää odotuksesi.

Emme ota vastuuta, jos laitetta muutetaan tai käytetään ohjeiden vastaisesti.

FI

**ATTENZIONE : (per conoscere le caratteristiche d'uso consultare il libretto di circolazione)**

Installato seguendo le nostre raccomandazioni, questo gancio da traino vi lascerà completamente soddisfatti.  
Respingiamo ogni responsabilità in caso di trasformazione o utilizzo illecito dello stesso.

IT

**LET OP : (voor gebruikkenmerken het kentekenbewijs raadplegen)**

Indien u de koppeling volgens onze aanbevelingen heeft geïnstalleerd, zal het u tot volle tevredenheid stemmen. Wij stellen ons niet aansprakelijk in geval van wijziging of onrechtmatig gebruik.

NL

**ADVARSEL: (for kunnskap om bruksegenskapene, se vognkortet)**

Ved å installere innretningen i samsvar med våre anbefalinger vil du få maksimalt utbytte av dette tilhengerfestet. Vi fraskriver oss alt ansvar hvis tilhengerfestet endres eller brukes på ulovlig måte.

NO

**POZOR: (užívateľské charakteristiky naleznete v technickém průkazu)**

Tažné zařízení instalované dle našich doporučení vás plně uspokojí. V případě přestavby nebo neoprávněného užívání se zbavujeme veškeré odpovědnosti

CZ

**VARNING: (Läs igenom registreringsbeviset för att ta reda på rådande användningsvillkor)**

Om du monterar produkten enligt våra anvisningar kommer du uppnå bästa möjliga resultat. Vi avsäger oss allt ansvar i de fall kunden inte följer våra anvisningar fullt ut.

SV

**FIGYELEM : (a használati jellegzetességeket a forgalmi engedélyből ismerheti meg)**

A vonóhorog előírásainknak megfelelő felszerelés esetén a terméket teljes elégedettséggel használhatja. A termék átalakítása vagy tiltott használata esetén semmilyen felelősséget nem vállalunk.

HU

**ВНИМАНИЕ : (чтобы ознакомиться с рабочими характеристиками, изучите технический паспорт автомашины)**

Установленное при соблюдении рекомендаций, данное тягово-сцепное устройство в полной мере удовлетворит ваши потребности. Производитель не несет никакой ответственности в случае деформации или

RU

**316 364 600 001 (SI 216)**  
**316 365 600 001 (SI 216)**  
**316 366 600 001 (SI 215)**

**D U S T E R**

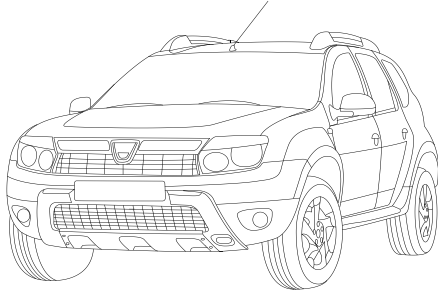

**D U S T E R**  
10/2017 →

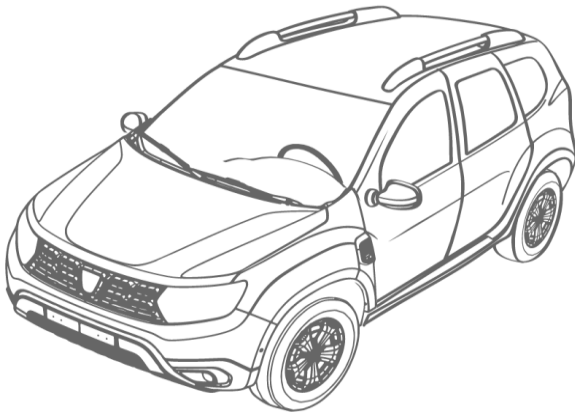

**Kg** 1600 kg

**Kg** 1950 kg

**Kg**  
75 kg



8,62 kN

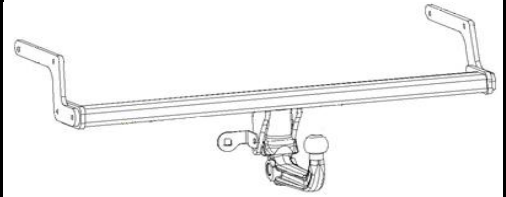

316364 : 18 kg  
 316365 : 16,5 kg  
 316366 : 18,5 kg



e24\*55R\*01\*0346 - 316364  
 e24\*55R\*01\*0346 - 316365  
 e24\*55R\*01\*0345 - 316366

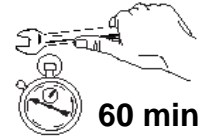
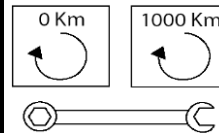

**316364**

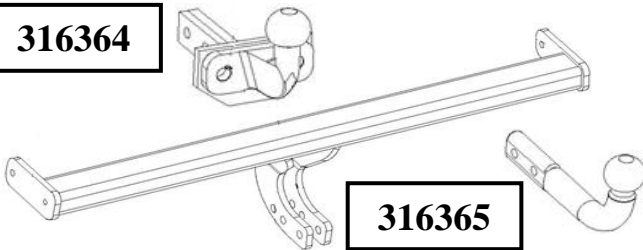

**316366**

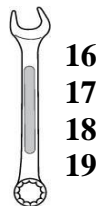
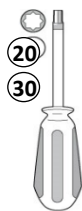
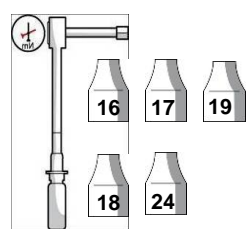
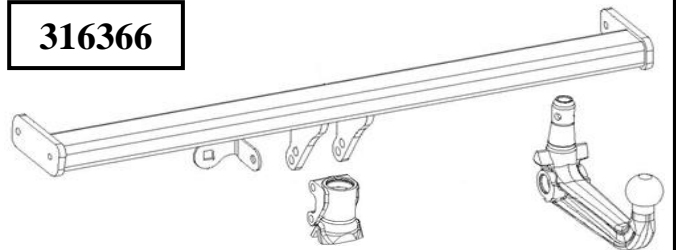



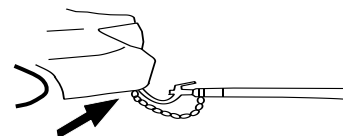
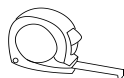
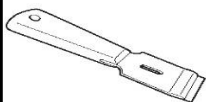
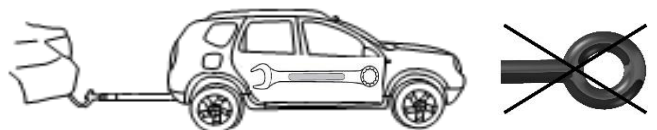



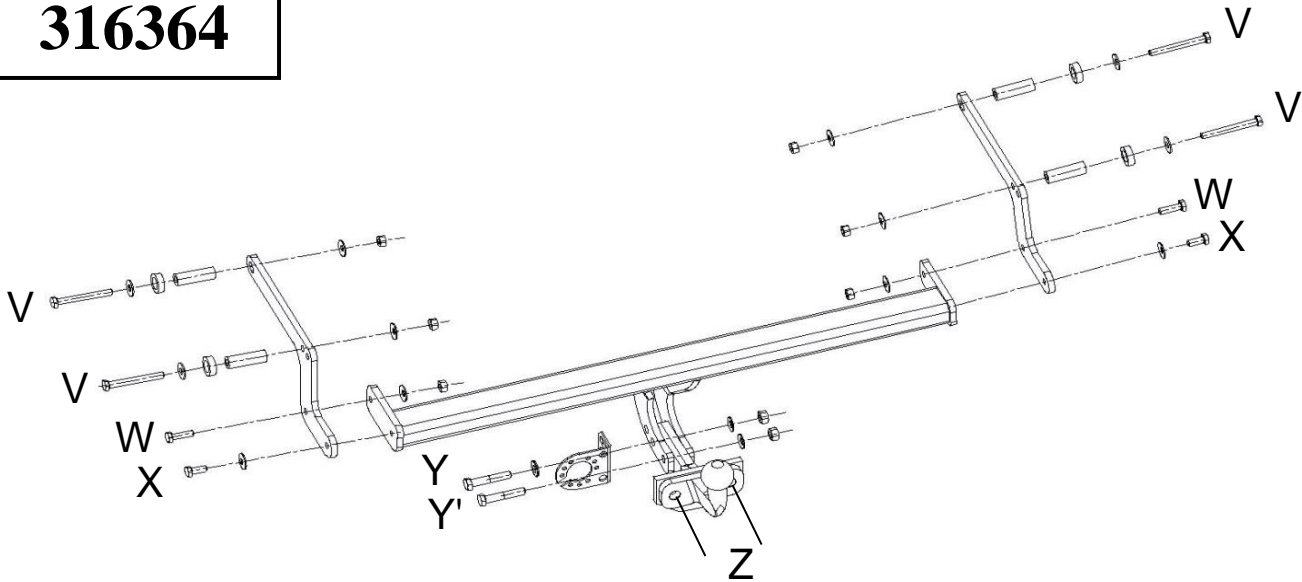













**OK**











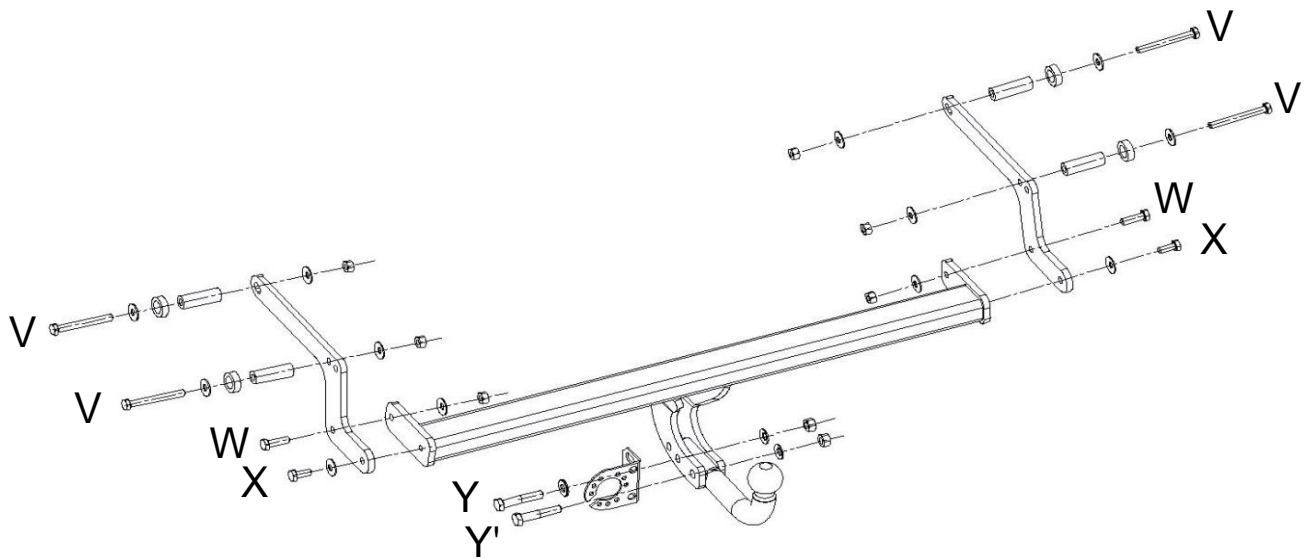









# 316364











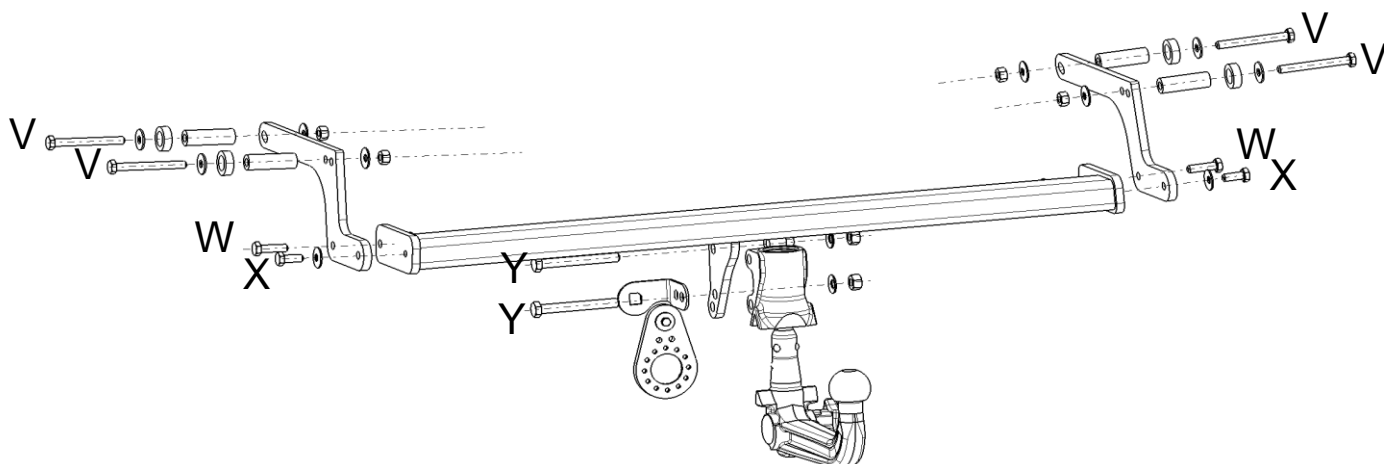





VISSERIE		QTE
<b>V</b>	 HM10x90 - 47Nm	x 4
	 CS 10/27	x 4
	 L10,5/27	x 4
	 20/32 - ep.10mm	x 4
	 M10	x 4
	 Ø10,5/20 - L. 60mm	x 4
<b>W</b>	 HM10x35 - 47Nm	x 2
	 CS 10/27	x 2
	 M10	x 2
<b>X</b>	 HM10x35 - 47Nm	x 2
	 CS 10/27	x 2
<b>Y</b>	 HM12x65 - 81Nm	x 1
	 CS12/24	x 1
	 M12	x 1
<b>Y'</b>	 HM12x65 - 81Nm	x 1
	 CS12/24	x 1
	 M12	x 1
	 D12	x 1
<b>Z</b>	 HM16x40 - 195Nm	x 2
	 M16	x 2
	 DEC16	x 2

# 316365



VISSERIE		QTE
<b>V</b>	 HM10x90 - 47Nm	x 4
	 CS 10/27	x 4
	 L10,5/27	x 4
	 20/32 - ep.10mm	x 4
	 M10	x 4
	 Ø10,5/20 - L. 60mm	x 4
<b>W</b>	 HM10x35 - 47Nm	x 2
	 CS10/27	x 2
	 M10	x 2
<b>X</b>	 HM10x35 - 47Nm	x 2
	 CS10/27	x 2
<b>Y</b>	 HM12x65 - 81Nm	x 1
	 CS12/24	x 1
	 M12	x 1
<b>Y'</b>	 HM12x65 - 81Nm	x 1
	 CS12/24	x 1
	 M12	x 1
	 L13/27	x 1

**316366**

<b>VISSERIE</b>		<b>QTÉ</b>
<b>V</b>	 HM10x90 - 47Nm	x 4
	 CS 10/27	x 4
	 L10,5/27	x 4
	 20/32 - ep.10mm	x 4
	 M10	x 4
	 Ø10,5/20 - L. 60mm	x 4
<b>W</b>	 HM10x35 - 47Nm	x 2
	 CS10/27	x 2
	 M10	x 2
<b>X</b>	 HM10x35 - 47Nm	x 2
	 CS10/27	x 2
<b>Y</b>	 HM12x100 - 114Nm	x 2
	 CS12/24	x 2
	 M12	x 2

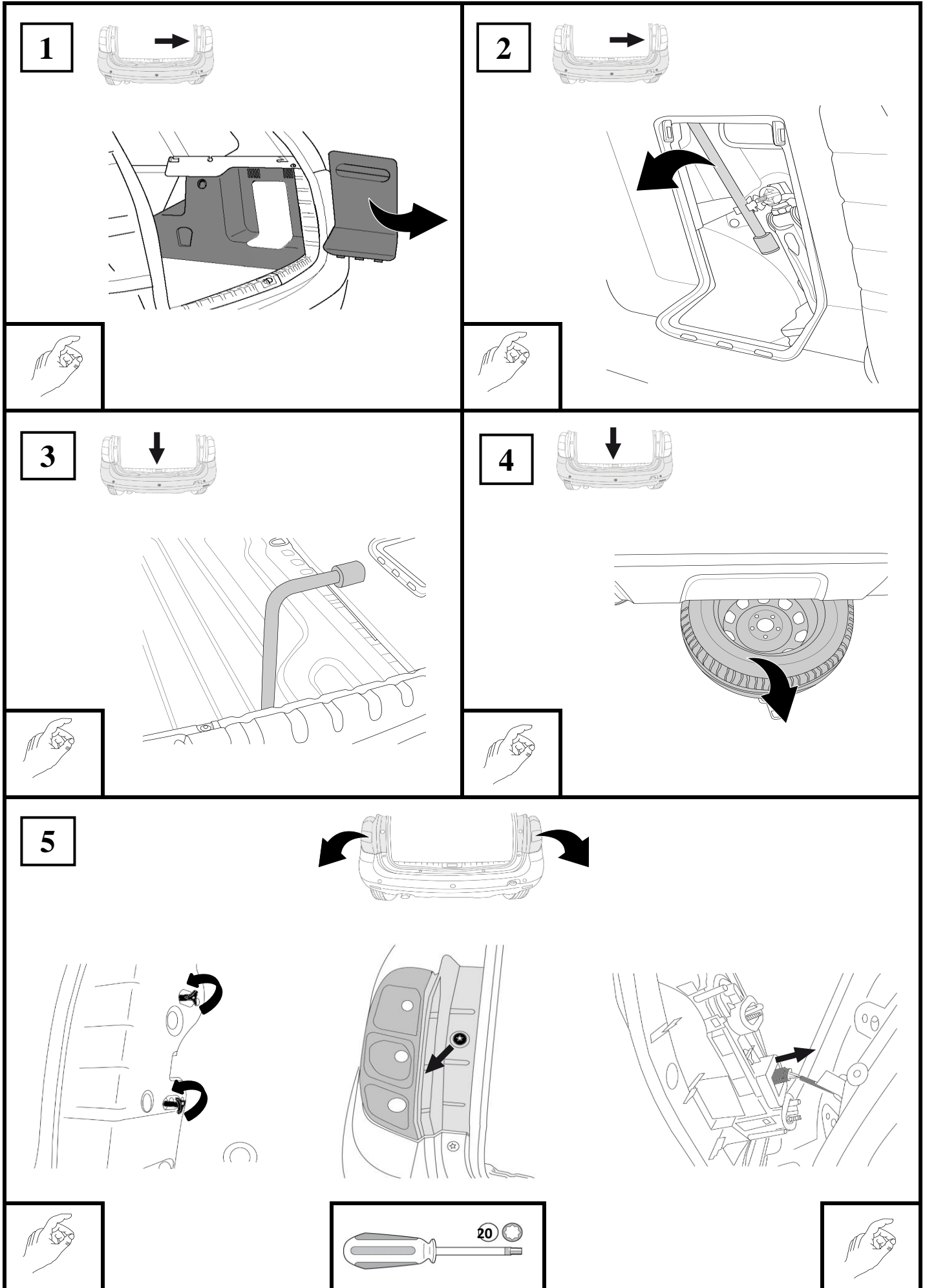

6

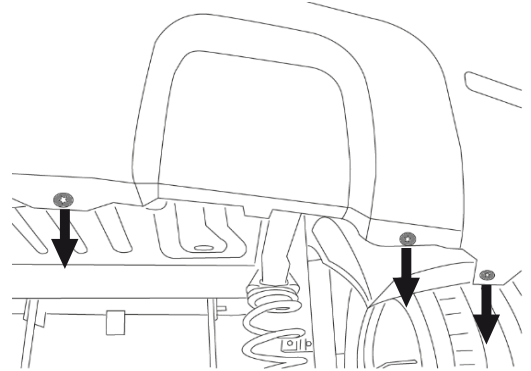
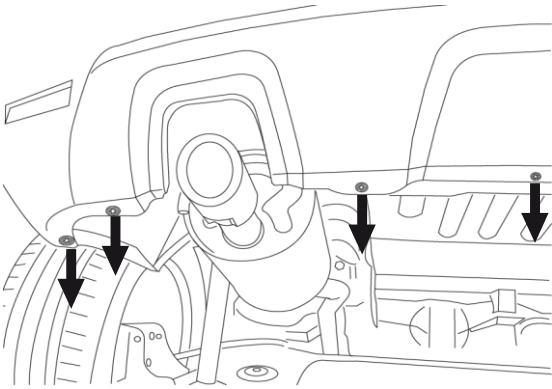
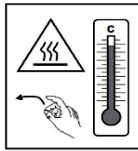
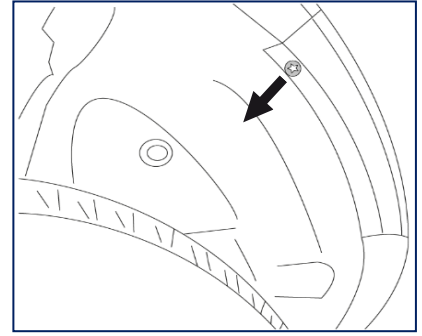
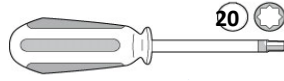
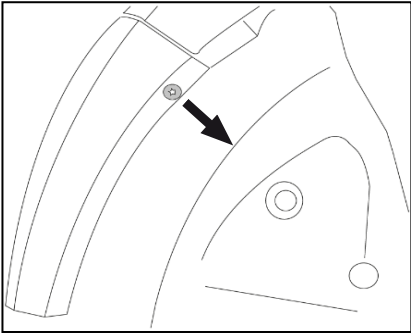
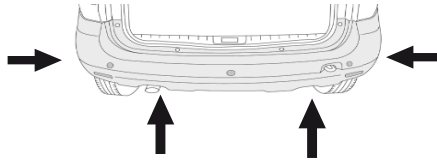

7

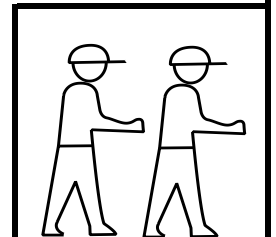
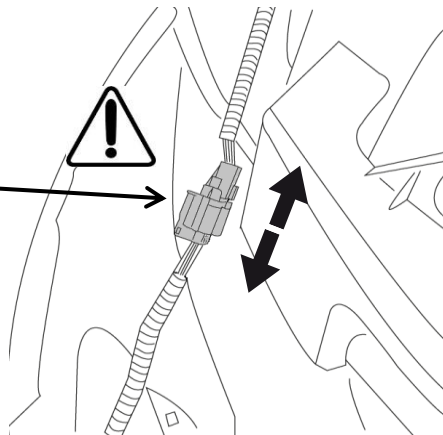
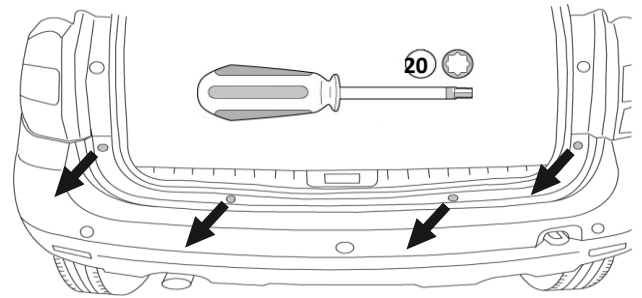
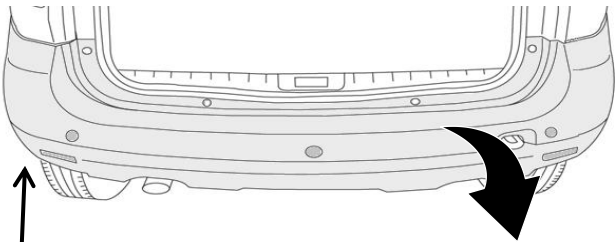
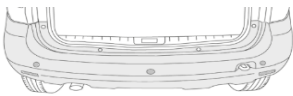



8

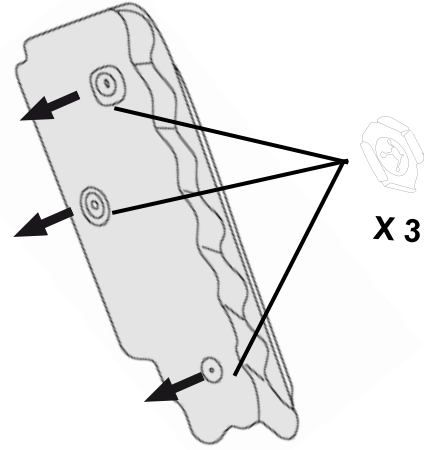
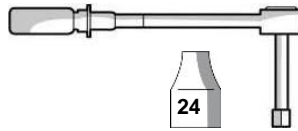
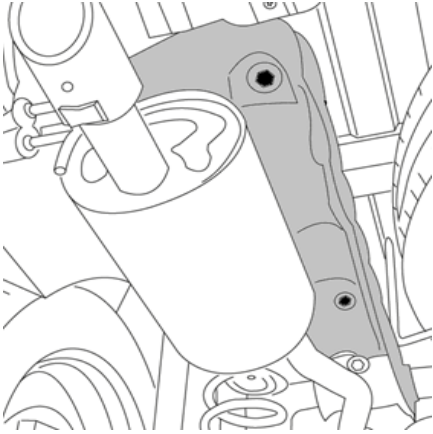
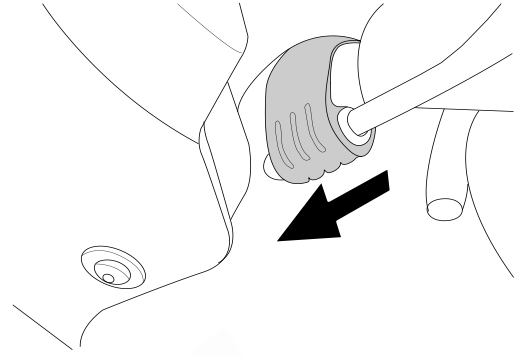
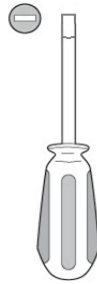
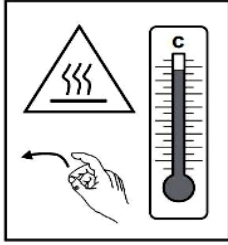

9

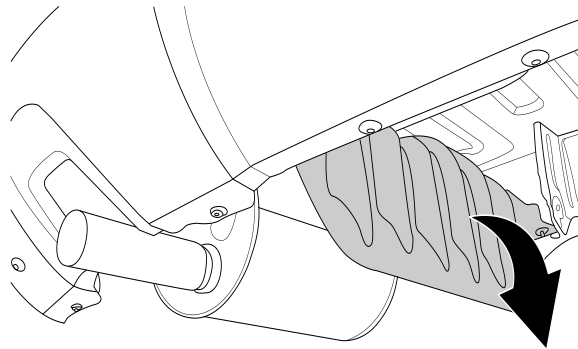

10

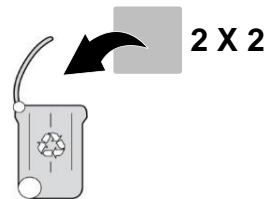
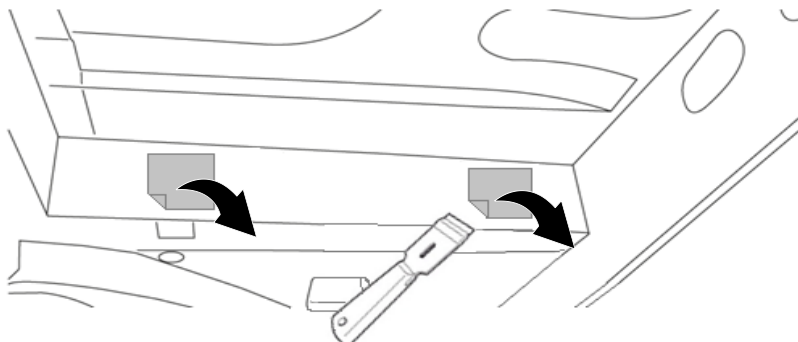
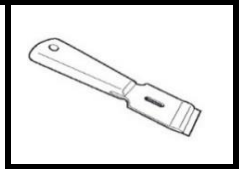
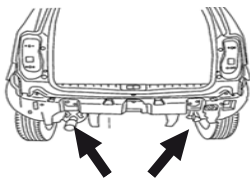



11

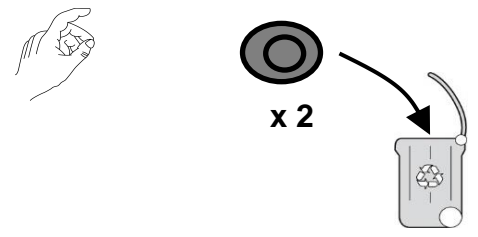
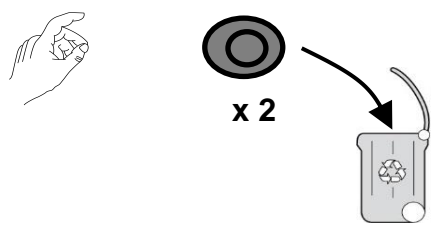
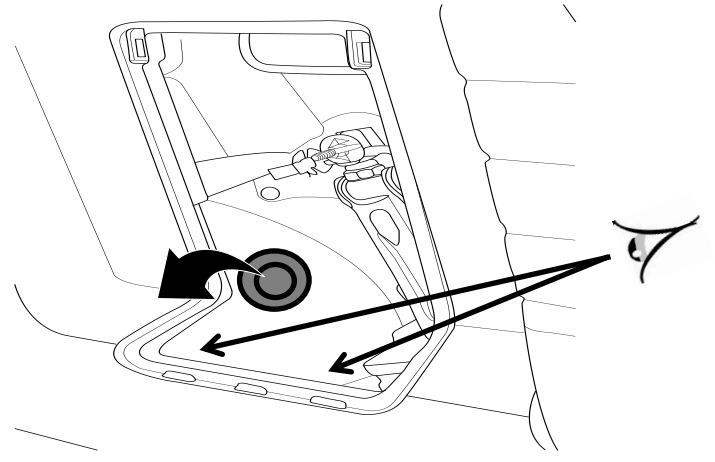
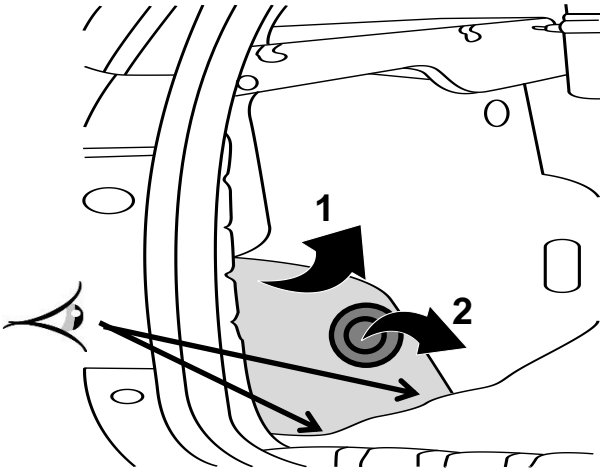
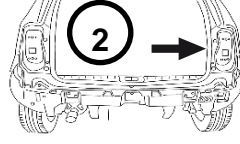
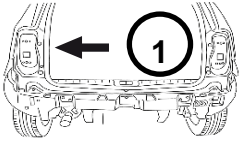

12

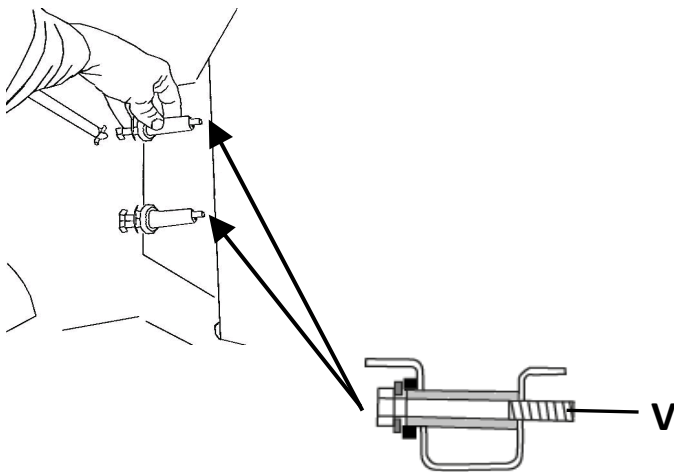
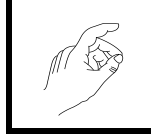
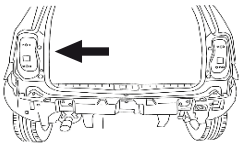

13

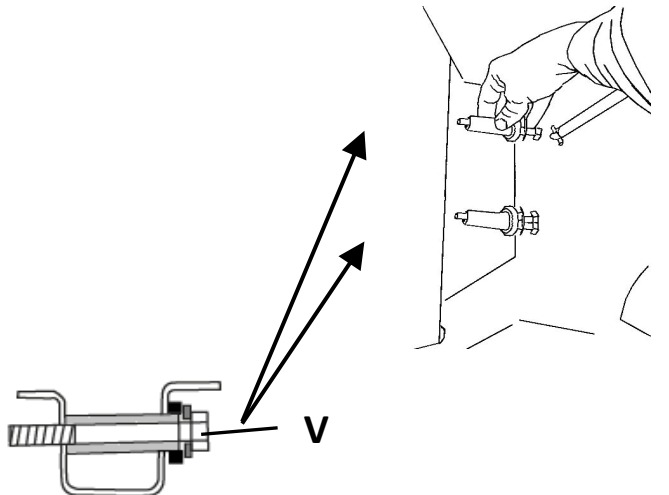
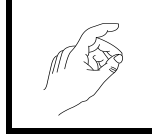
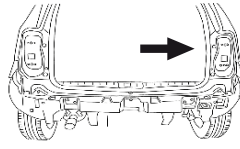

14

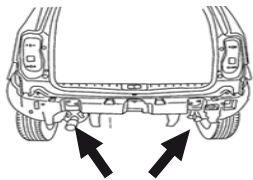

16 - 17

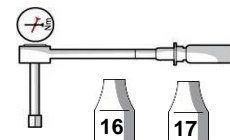

 47 Nm

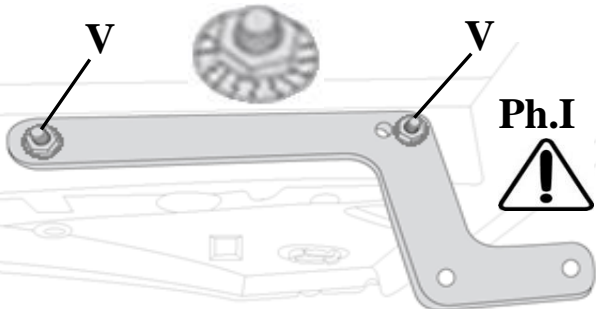

Ph.I

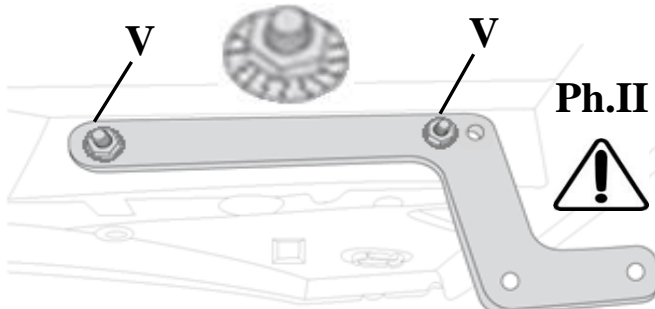

Ph.II

15

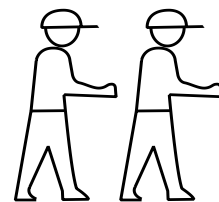
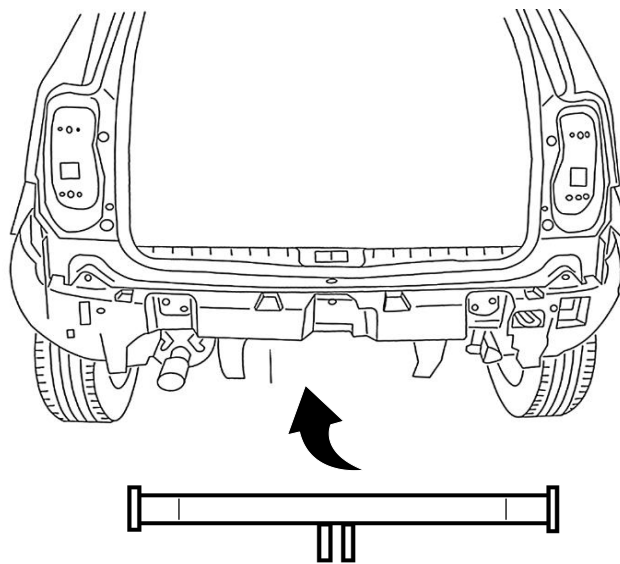

16

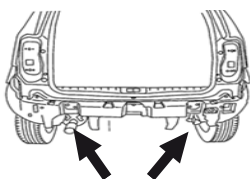

16 - 17

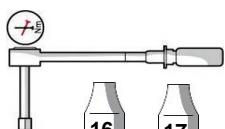

16 17

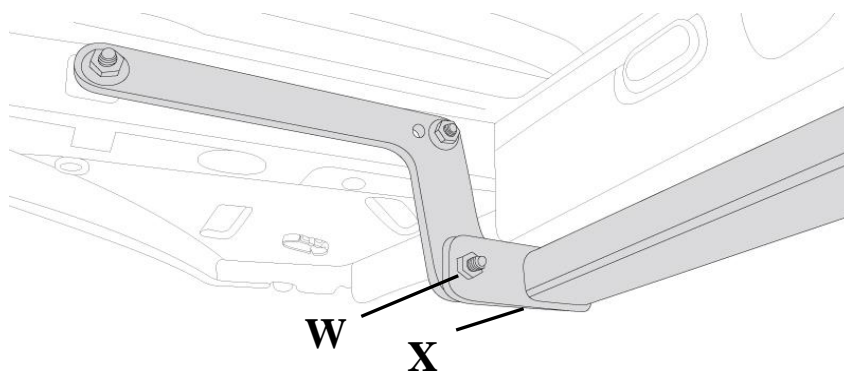

W

X

 47 Nm

17

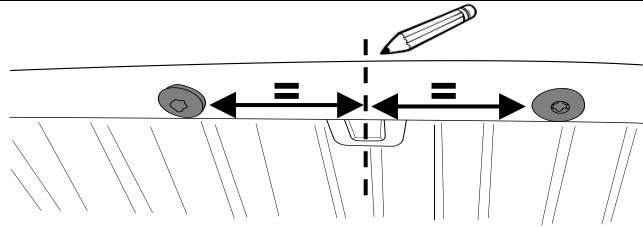
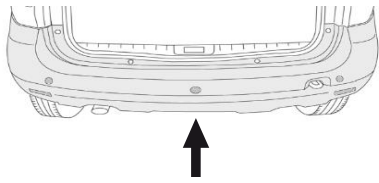

18

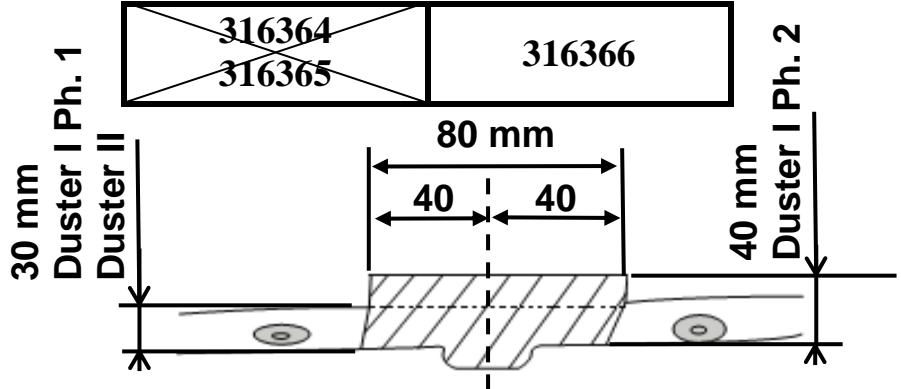
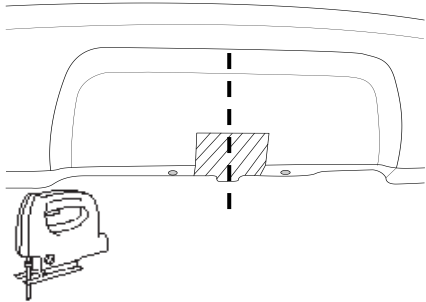

19



Y Y' = 81 Nm  
Z = 195 Nm

316 364

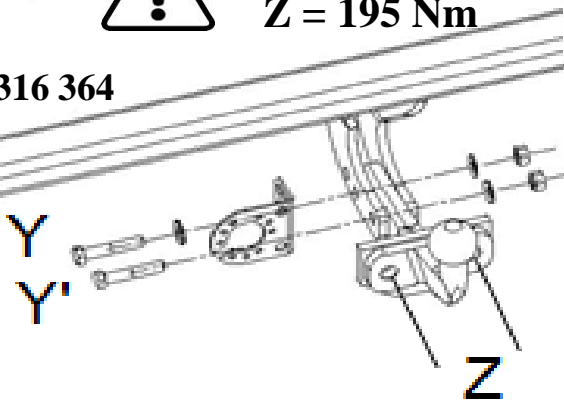

81 Nm

316 365

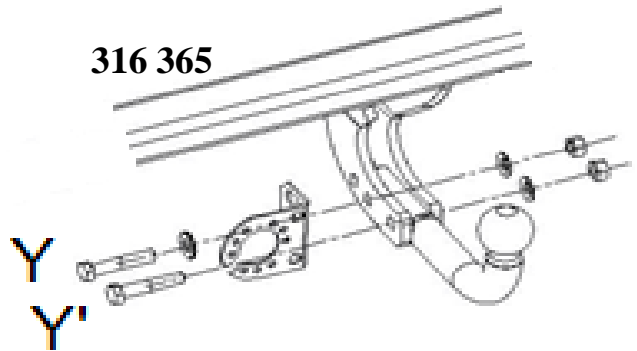

316 366

DUSTER

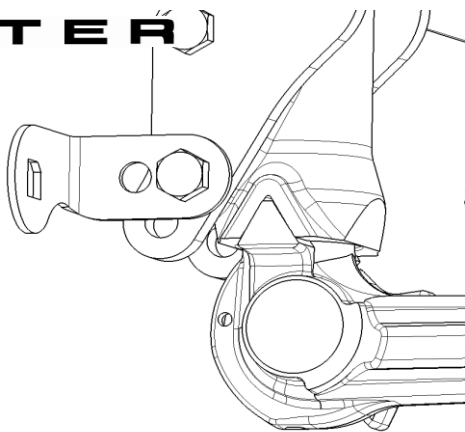

DUSTER

10/2017 →

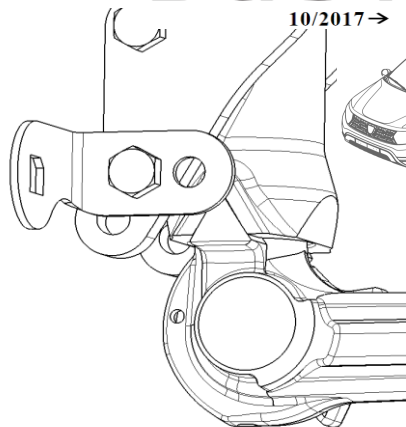

18 - 19 - 24

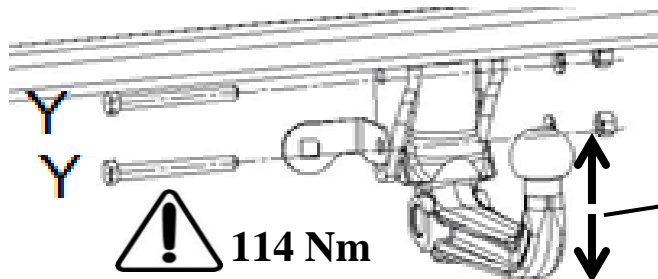

114 Nm

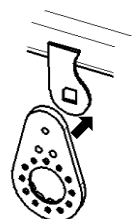

20

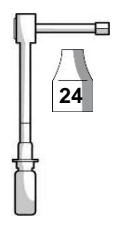
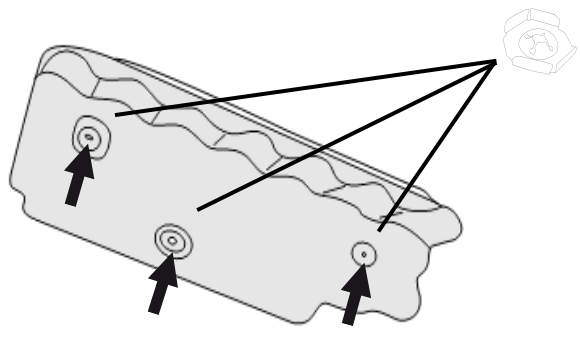
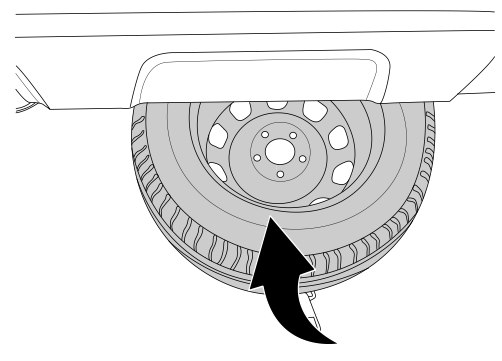
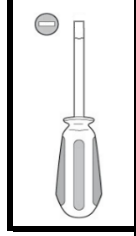
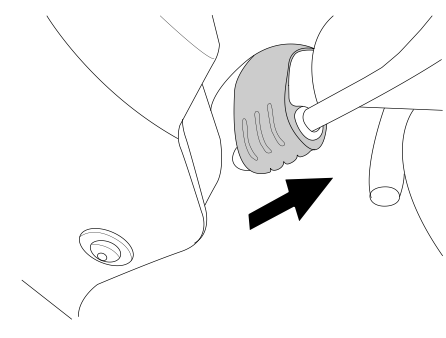
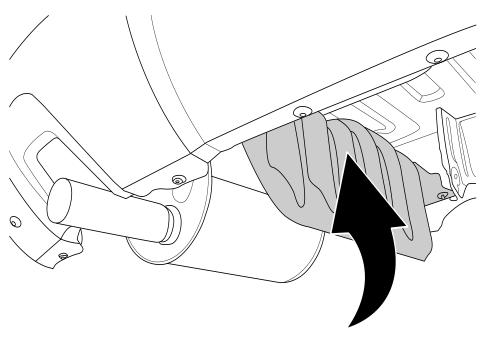

21

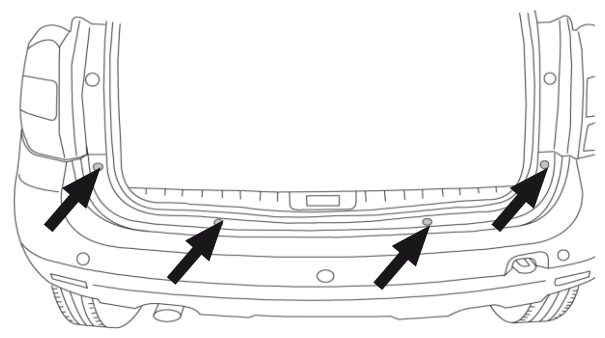
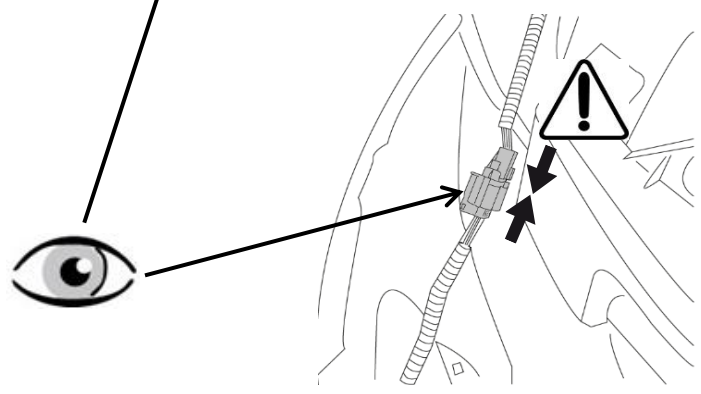
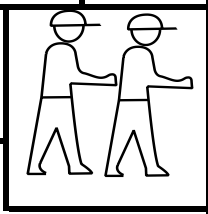
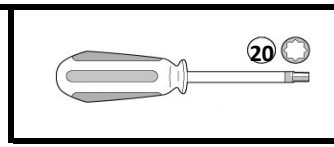
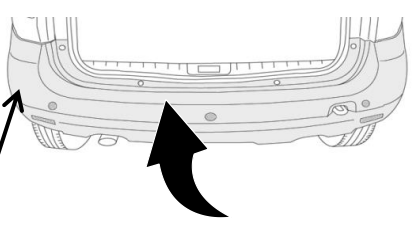

22

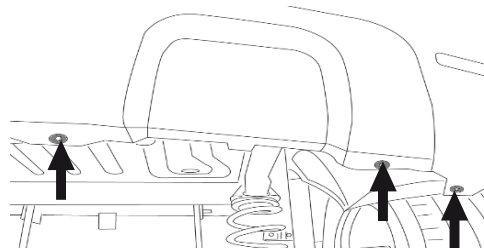
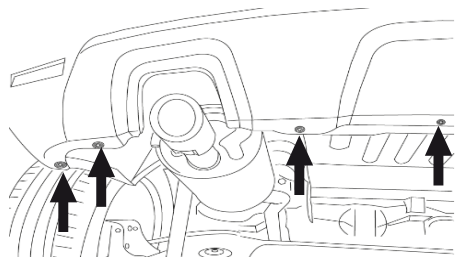
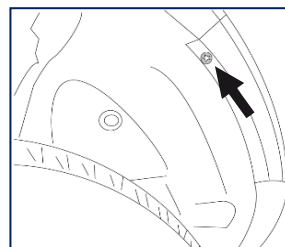
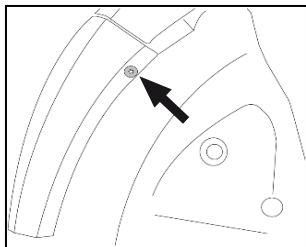
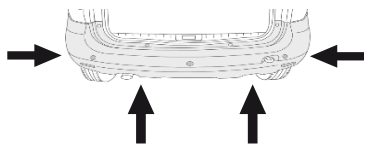

23

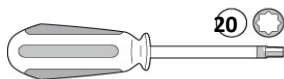
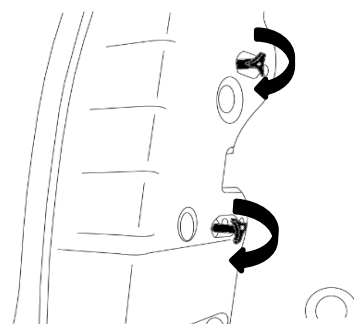
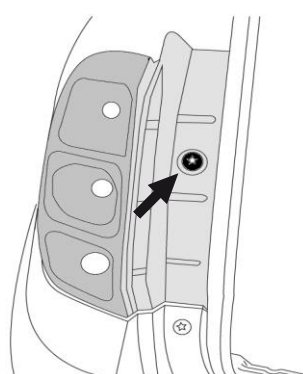
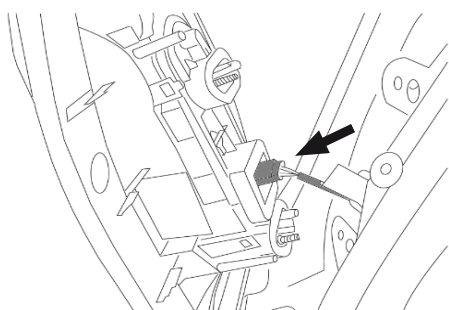
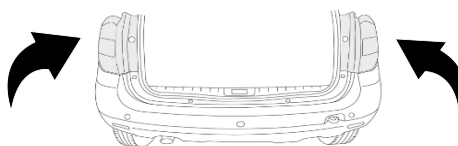

24

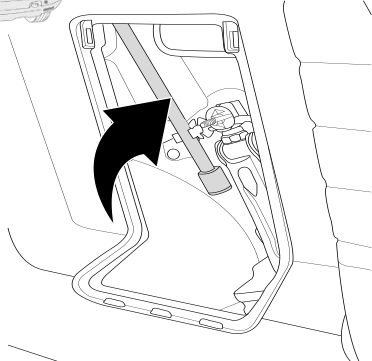
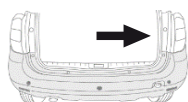

25

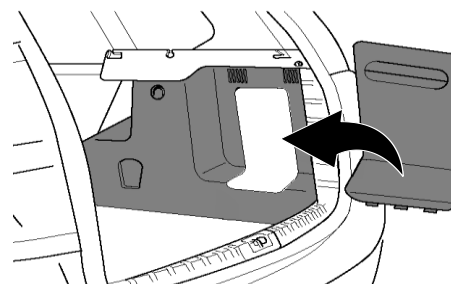
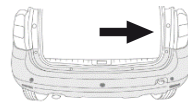

Dispositivo di traino tipo : **316364 / 316365 / 316366**  
Per autoveicolo : **Dacia Duster**  
Tipo funzionale : **SD**

Classe e tipo di attacco : **A50-X**  
Omologazione : **e24\*55R\*01\*0346 (316364 - 316365) - e24\*55R\*01\*0345 (316366)**  
Valore D : **8,62 kN**  
Carico verticale max. S : **75 kg**  
Massa rimorchiabile : vedi carta di circolazione dell'autoveicolo



In base alla Direttiva europea R55, la massa massima rimorchiabile del dispositivo di traino è determinata dal valore di prova "D" così definito :

$$D = (T \times C) / (T + C) \times 0,00981 = 8,62 \text{ kN}$$

dove : T = Massa complessiva max. della motrice (in kg) e C = Massa rimorchiabile max. della motrice (in kg)

#### DICHIARAZIONE DI CORRETTO MONTAGGIO :

la sottoscritta Ditta dichiara che il dispositivo di traino tipo \_\_\_\_\_ è stato installato a regola d'arte, nel rispetto dei punti d'attacco e delle prescrizioni fornite dalla Casa costruttrice

sul veicolo Dacia Duster

targato \_\_\_\_\_

li \_\_\_\_\_

Si dichiara inoltre di aver informato l'utente del veicolo sull'USO e MANUTENZIONE del dispositivo stesso.

timbro et firma



[holownicze.pl](http://holownicze.pl)