

# 315173600001 - 315175600001 - 315180600001 - 315182600001

**ATTENTION : (pour connaître les caractéristiques d'utilisation consulter la carte grise).**

Installé suivant nos recommandations, cet attelage vous donnera entière satisfaction. Nous dégageons toute responsabilité en cas de transformation ou d'utilisation illicite de celui-ci

**FR**

**ACHTUNG: (Nutzungsmerkmale : siehe Fahrzeugschein)**

Diese Anhängervorrichtung wird Sie voll zufrieden stellen, wenn Sie unsere Montageanleitung befolgen. Im Falle der unerlaubten Veränderung oder des unerlaubten Gebrauchs lehnen wir jede Haftung ab.

**DE**

**PLEASE NOTE : (to familiarise yourself with the operating characteristics refer to the log).**

If this tow bar is fitted in accordance with our recommendations it will give a completely satisfaction. We cannot accept any responsibility in the event of changes to or improper use of this item.

**EN**

**BEMÆRK : (for yderligere oplysninger om anvendelsesforhold henvises der til registreringsattesten)**

Hvis dette anhængertræk monteres i henhold til vores anvisninger, vil det være til din fulde tilfredshed. Vi fralægger os ethvert ansvar ved ulovlig ændring eller brug af anhængertrækket.

**DA**

**ΠΡΟΣΟΧΗ : (για να πληροφορηθείτε τα χαρακτηριστικά χρήσης συμβουλευτείτε την γκριζα κάρτα)**

Εγκατεστημένο σύμφωνα με τις συστάσεις μας, αυτό το σύστημα ρυμούλκησης θα σας ικανοποιήσει πλήρως. Απεκδύομεθα πάσης ευθύνης σε περίπτωση μετατροπής ή παράνομης χρήσης αυτού.

**EL**

**ATENCIÓN: (para conocer las características de utilización, consultar el permiso de circulación)**

Instalado siguiendo nuestras recomendaciones, este enganche le dará total satisfacción. No asumiremos ninguna responsabilidad en caso de que haya sido transformado o utilizado ilícitamente.

**ES**

**UWAGA (charakterystyki użytkowania należy sprawdzić w dowodzie rejestracyjnym)**

Dyszel holowniczy będzie funkcjonował we właściwy sposób po zainstalowaniu go zgodnie z zaleceniami. Nie ponosimy żadnej odpowiedzialności w przypadku wprowadzenia zmian lub niedozwolonego użycia

**PL**

**HUOMIO: (käyttöominaisuuksiin tutustumiseksi on katsottava rekisteriotetta)**

Suosituksen mukaan asennettuna tämä vetokoukku täyttää odotuksesi.

Emme ota vastuuta, jos laitetta muutetaan tai käytetään ohjeiden vastaisesti.

**FI**

**ATTENZIONE : (per conoscere le caratteristiche d'uso consultare il libretto di ircolazione)**

Installato seguendo le nostre raccomandazioni, questo gancio da traino vi lascerà completamente soddisfatti. Respingiamo ogni responsabilità in caso di trasformazione o utilizzo illecito dello stesso.

**IT**

**LET OP : (voor gebruikskennmerken het kentekenbewijs raadplegen)**

Indien u de koppeling volgens onze aanbevelingen heeft geïnstalleerd, zal het u tot volle tevredenheid stemmen. Wij stellen ons niet aansprakelijk in geval van wijziging of onrechtmatig gebruik.

**NL**

**ADVARSEL: (for kunnskap om bruksegenskapene, se vognkortet)**

Ved å installere innretningen i samsvar med våre anbefalinger vil du få maksimalt utbytte av dette tilhengerfestet. Vi fraskriver oss alt ansvar hvis tilhengerfestet endres eller brukes på ulovlig måte.

**NO**

**POZOR: (užívateľské charakteristiky naleznete v technickém průkazu)**

Tažné zařízení instalované dle našich doporučení vás plně uspokojí. V případě představby nebo neoprávněného užívání se zbavujeme veškeré odpovědnosti

**CZ**

**VARNING: (Läs igenom registreringsbeviset för att ta reda på rådande användningsvillkor)**

Om du monterar produkten enligt våra anvisningar kommer du uppnå bästa möjliga resultat. Vi avsägar oss allt ansvar i de fall kunden inte följt våra anvisningar fullt ut.

**SV**

**FIGYELEM : (a használati jellegzetességeket a forgalmi engedélyből ismerheti meg)**

A vonóhorog előírásainknak megfelelő felszerelése esetén a terméket teljes elégedettséggel használhatja. A termék átalakítása vagy tiltott használata esetén semmilyen felelősséget nem vállalunk.

**HU**

**ВНИМАНИЕ : (чтобы ознакомиться с рабочими характеристиками, изучите технический паспорт автомашины)**

Установленное при соблюдении рекомендаций, данное тягово-сцепное устройство в полной мере удовлетворит ваши потребности. Производитель не несет никакой ответственности в случае деформации или

**RU**

**31517360001**  
(RLD BL)  
**31518060001**  
(RLD BK)  
**SI159**

**31517560001**  
(RDSO BL)  
**31518260001**  
(RDSO BK)  
**SI160**

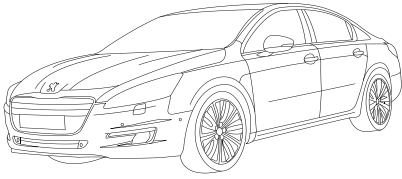

**508**

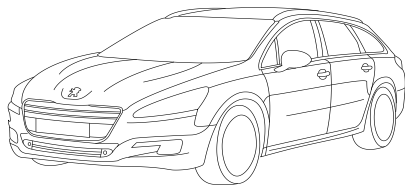

2297 kg



1900 kg



75 kg



SI159  
e24\*R55\*01\*0172

SI160  
e24\*R55\*01\*0173

SI177  
e24\*R55\*01\*0257

SI178  
e24\*R55\*01\*0258

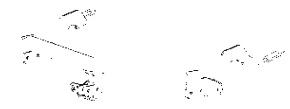

20,5 kg

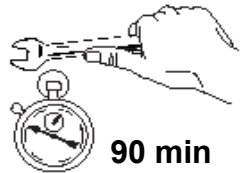
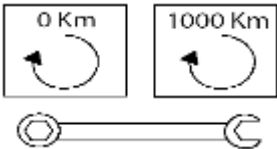

**90 min**



10,19 kN

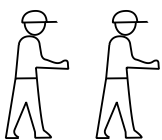
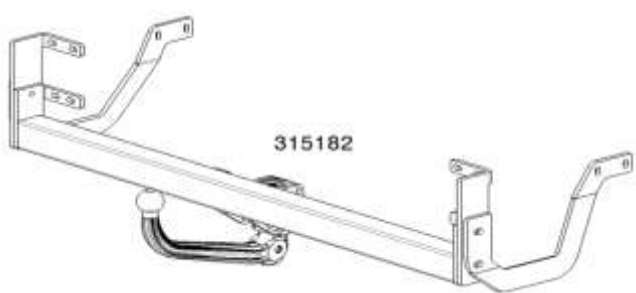
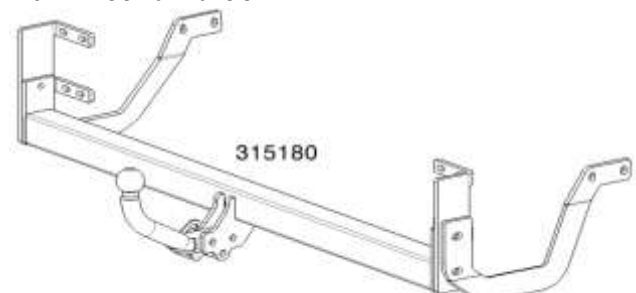







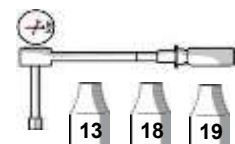

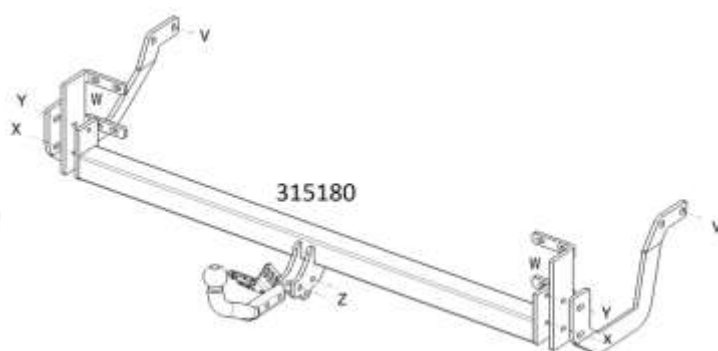
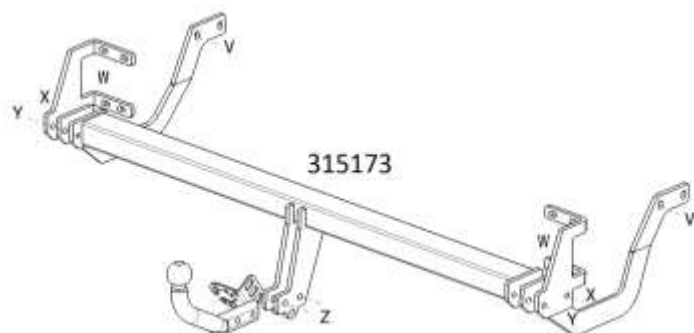





**T25**











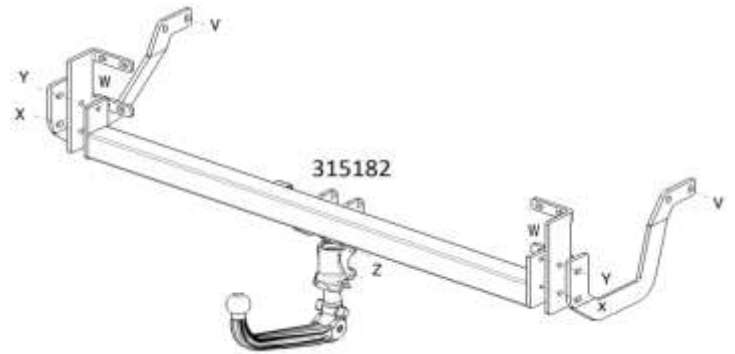
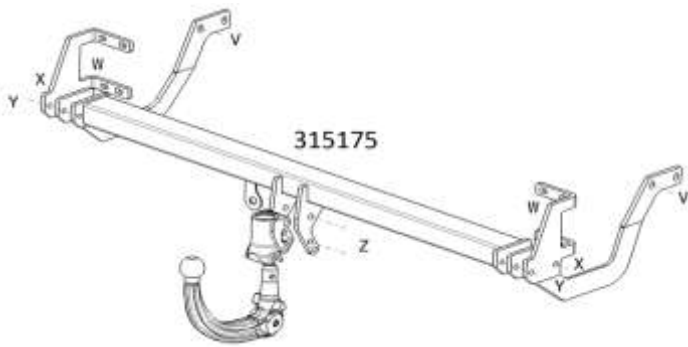





**13 - 18 - 19**



**315173****315180**

VISSERIE		QTÉ
<b>V</b>	 HM10x50 - cl8.8 - 40Nm	x 2
	 DEC10	x 2
	 L10/22	x 2
<b>W</b>	 HM8x50 - cl8.8 - 23Nm	x 8
	 DEC8	x 8
	 L8/27	x 8
<b>X</b>	 HM10x50 - cl8.8 - 40Nm	x 2
	 DEC10	x 2
<b>Y</b>	 HM10x50 - cl8.8 - 40Nm	x 2
	 DEC10	x 2
	 M10 - cl8 - 40Nm	x 2
<b>Z</b>	 HM12x60 - cl8.8 - 65Nm	x 2
	 L12/27	x 1
	 M12 - cl8 - 65Nm	x 2

**315175****315182**

<b>VISSERIE</b>		<b>QTÉ</b>
<b>V</b>	 HM10x50 - cl8.8 - 40Nm	x 2
	 DEC10	x 2
	 L10/22	x 2
<b>W</b>	 HM8x50 - cl8.8 - 23Nm	x 8
	 DEC8	x 8
	 L8/27	x 8
<b>X</b>	 HM10x50 - cl8.8 - 40Nm	x 2
	 DEC10	x 2
<b>Y</b>	 HM10x50 - cl8.8 - 40Nm	x 2
	 DEC10	x 2
	 M10 - cl8 - 40Nm	x 2
<b>Z</b>	 HM12x100 - cl10.9 - 95Nm	x 2
	 DEC12	x 2
	 M12 - cl10.9 - 95Nm	x 2

1

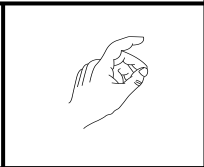
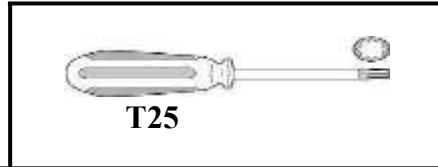
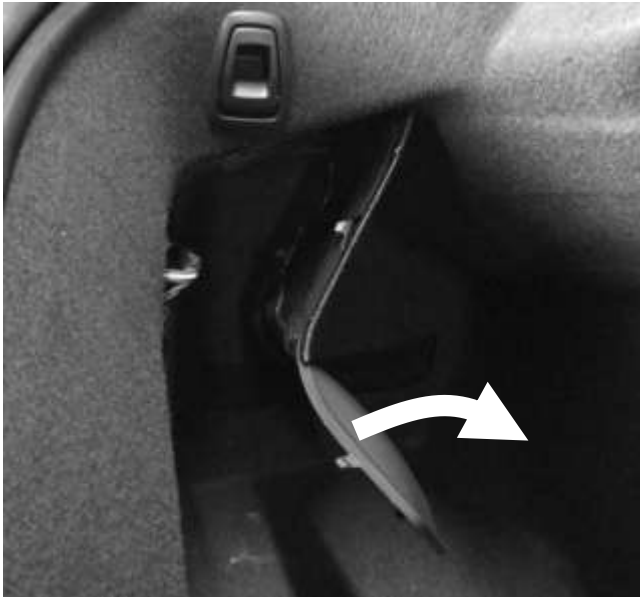
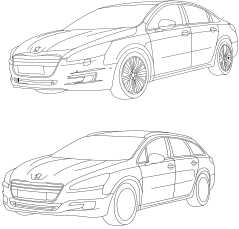

2

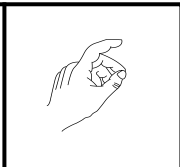
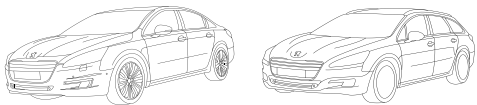



**3**

T25  
T30

**4**

x 2

T30

**5**

x 3

T25



**6**

x 2

T25



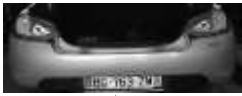

**7**



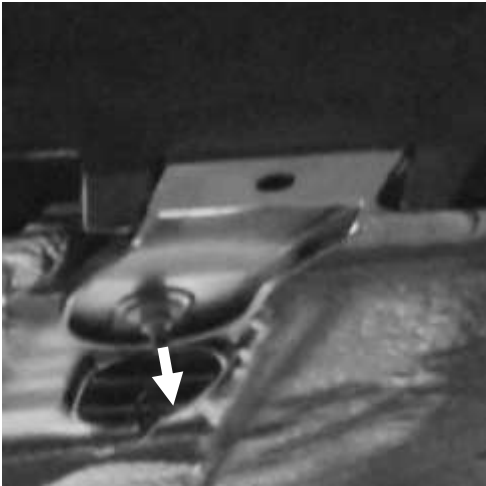

13

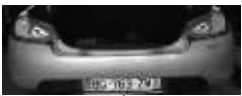

**8**



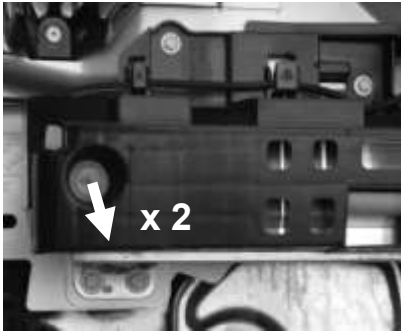





**9**









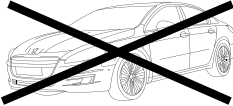

T25

**10**

**11**

12



13

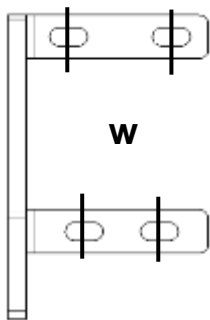
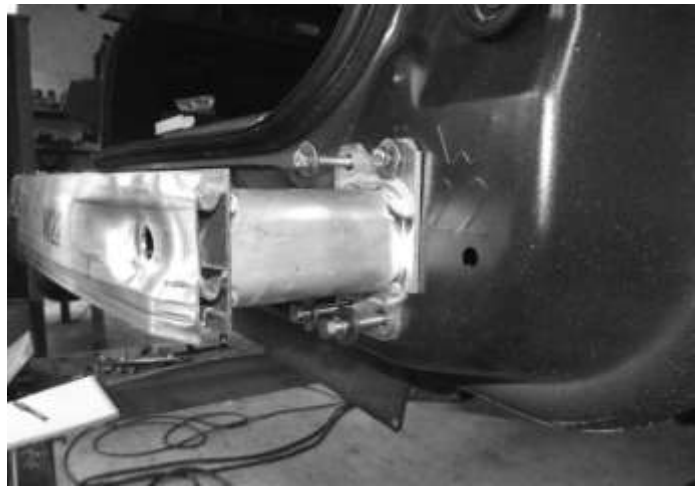
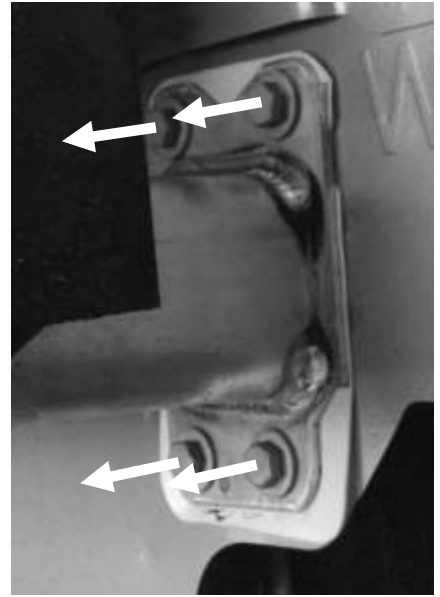
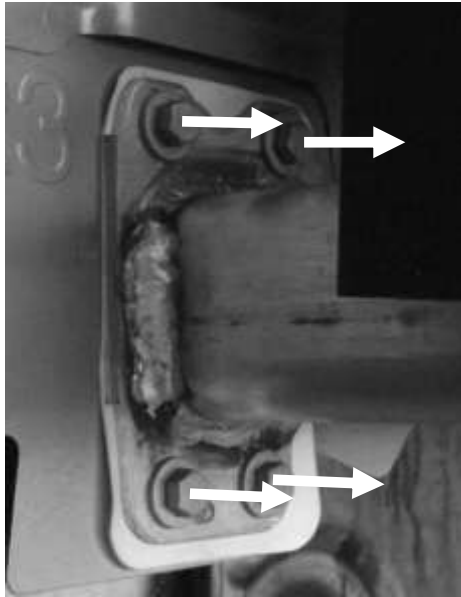

W

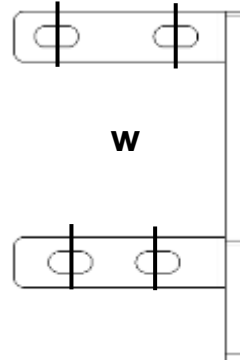

W



13  
17  
18  
19

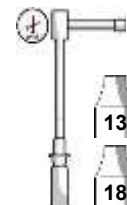

13 17  
18 19



13

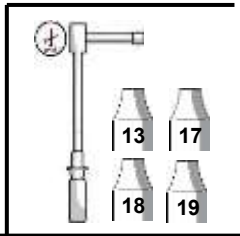
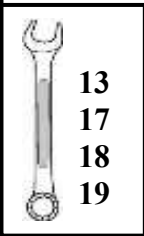
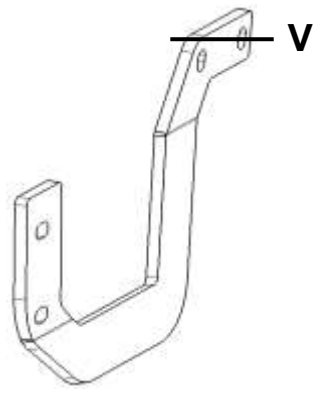
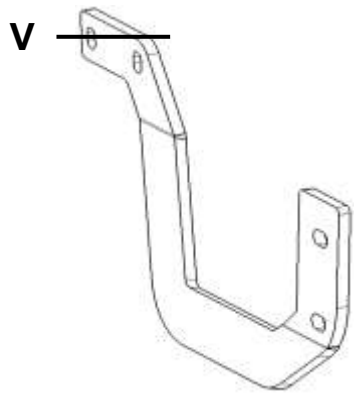
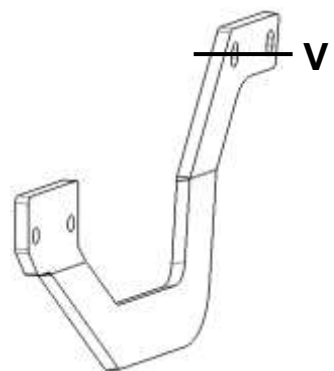
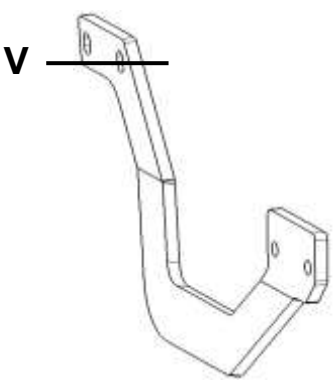
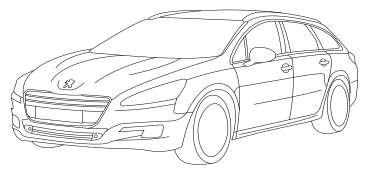
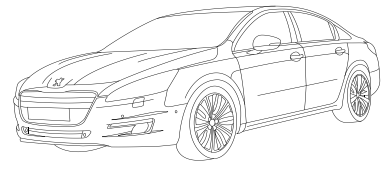
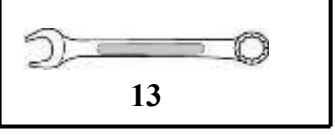

14

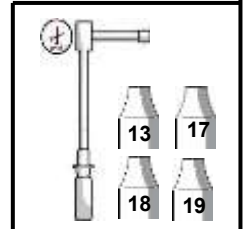
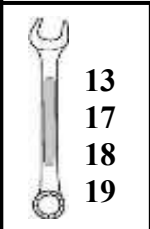
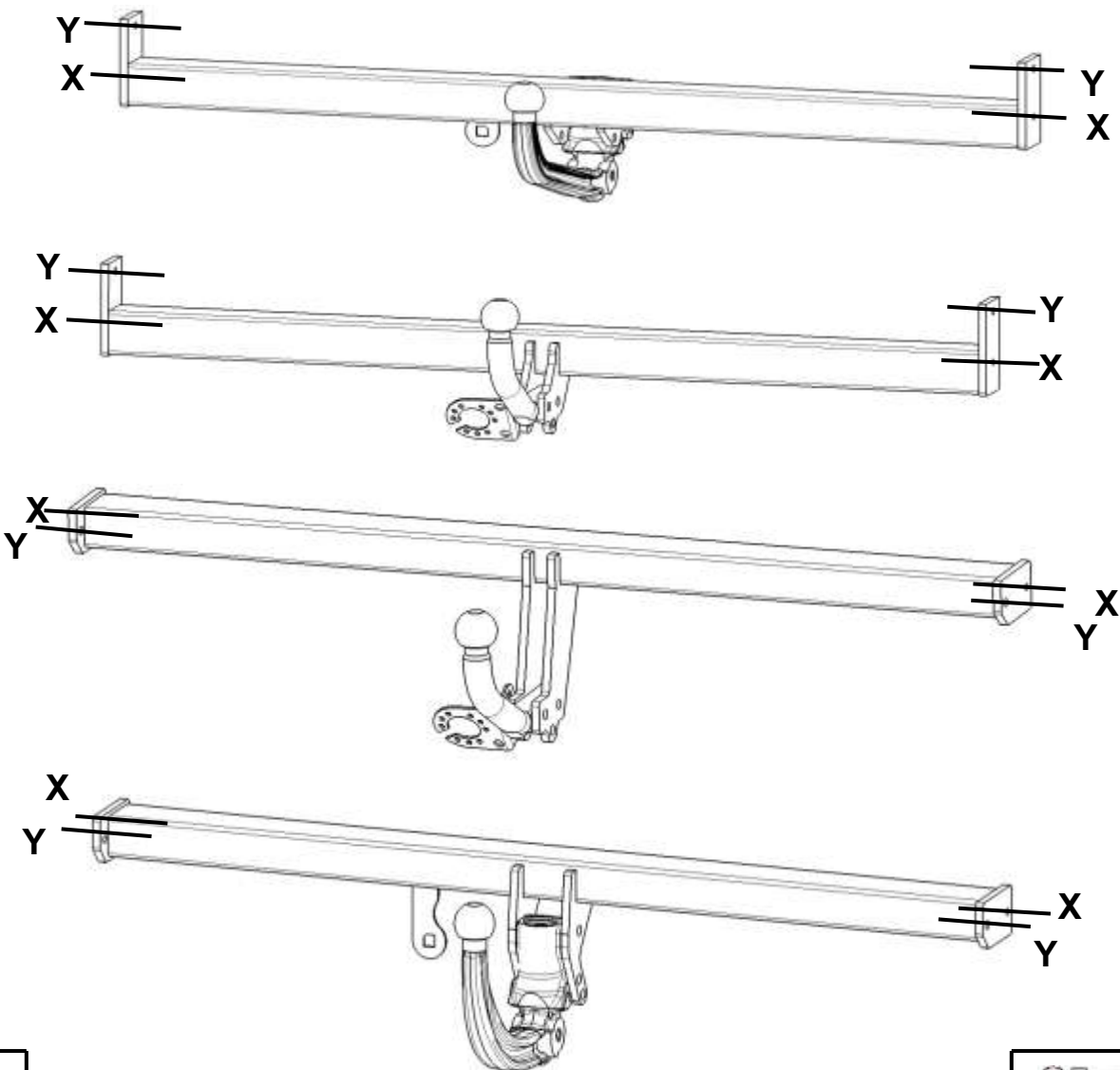
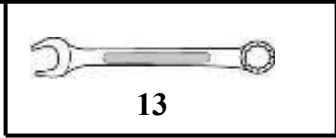

15

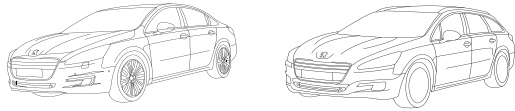

17 - 18 - 19

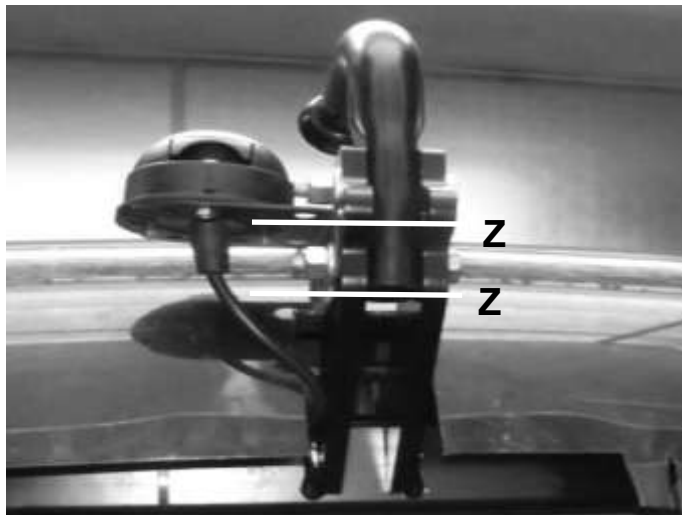
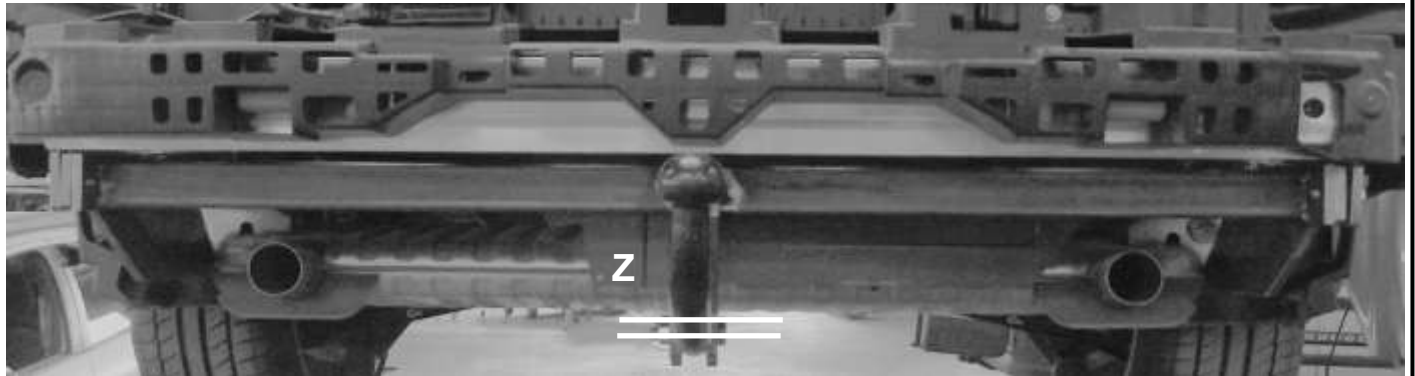
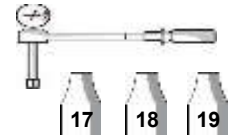

16

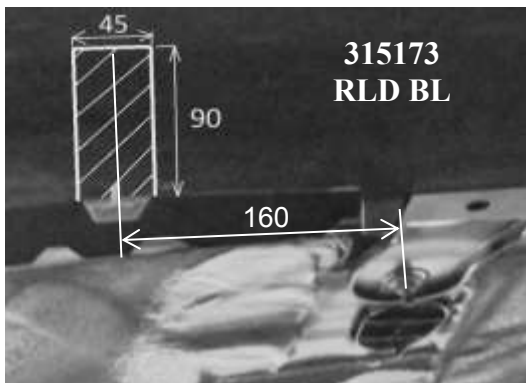

315173  
RLD BL

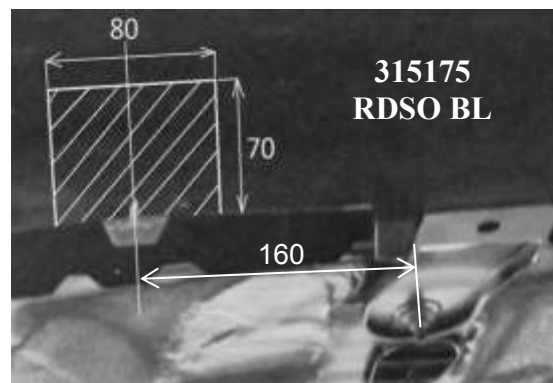

315175  
RDSO BL

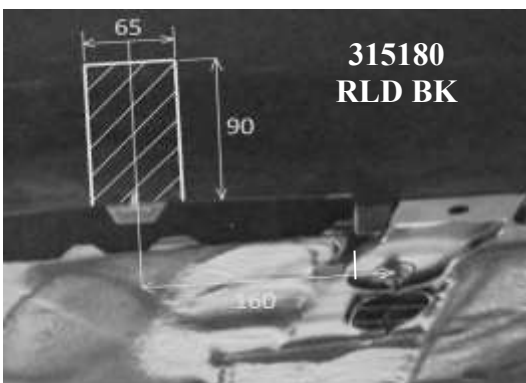

315180  
RLD BK

Dispositivo di traino tipo : **315173 - 315175 - 315180 - 315182**  
Per autoveicolo : **Peugeot 508 Berline et Break**  
Tipo funzionale : **8D / 8E**



Classe e tipo di attacco : **A50-X**  
Omologazione : **e24\*R55\*01\*0172 (SI159) - e24\*R55\*01\*0173 (SI160°**  
Valore D : **10,19 kN**  
Carico verticale max. S : **75 kg**  
Massa rimorchiabile : **vedi carta di circolazione dell'autoveicolo**

In base alla Direttiva europea 94/20, la massa massima rimorchiabile del dispositivo di traino è determinata dal valore di prova "D" così definito :

$$D = (T \times C) / (T + C) \times 0,00981 = 3 \text{ kN}$$

dove : T = Massa complessiva max. della motrice (in kg) e C = Massa rimorchiabile max. della motrice (in kg)

#### DICHIARAZIONE DI CORRETTO MONTAGGIO :

la sottoscritta Ditta dichiara che il dispositivo di traino tipo \_\_\_\_\_ è stato installato a regola d'arte, nel rispetto dei punti d'attacco e delle prescrizioni fornite dalla Casa costruttrice

sul veicolo Berlingo/Partner

targato \_\_\_\_\_

il \_\_\_\_\_

Si dichiara inoltre di aver informato l'utente del veicolo sull'USO e MANUTENZIONE del dispositivo stesso.

timbro et firma



[holownicze.pl](http://holownicze.pl)